

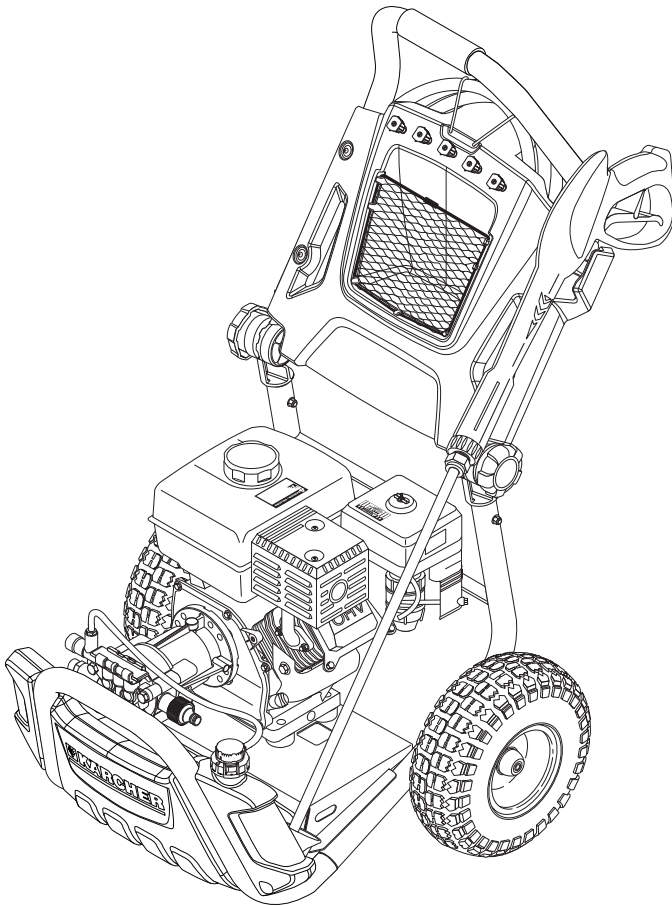

KÄRCHER®

Manual not for use
in USA and Canada!

G 3200 XH





Register and win!
www.kärcher.com



8.752-801.0 05/12

HIGH PRESSURE WASHER OPERATOR MANUAL

Dear Customer,

  Please read and comply with these original instructions prior to the initial operation of your appliance and store them for later use or subsequent owners.

Model Overview	4
Important Safety Instructions	5
Assembly Instructions	6
Operating Instructions	8
Using the Accessories	10
Working With Detergents	10
Taking a Break	11
Shutting Down & Clean-Up	12
Long Term Storage	12
Maintenance Instructions	12
Cleaning Tips	13
Troubleshooting	14

Specifications

G3200 XH AUS	
Operating Pressure	3200 PSI
Water Volume	10.6 L/Min
Detergent Suction	.56 - .76 L/Min
Engine	Honda GX200
Part No.	1.107-214.0
Serial No.	

Proper Use

This high-pressure cleaner is designed:

- to clean machines, vehicles, buildings, tools, facades, terraces, garden equipment etc. using a high-pressure water jet (and detergents if required).
- with accessories, replacement parts and detergents approved by KÄRCHER. Observe the instructions provided with these detergents.

Environmental protection



The packaging material can be recycled. Please do not place the packaging into the ordinary refuse for disposal, but arrange for the proper recycling.



Old appliances contain valuable materials that can be recycled. Please arrange for the proper recycling of old appliances. Please dispose your old appliances using appropriate collection systems.

Notes about the ingredients (REACH)

You will find current information about the ingredients at:

<http://www.karcher.de/de/unternehmen/umweltschutz/REACH.htm>

Safety Alert Symbols

DANGER

Indicates “an imminently hazardous situation which, if not avoided, will result in death or serious injury.”

WARNING

Indicates “a potentially hazardous situation which, if not avoided, could result in death or injury.”

CAUTION

Indicates “a potentially hazardous situation which, if not avoided, may result in minor or moderate injury or in property damage incidents.”

Owner/User Responsibility

The owner and/or user must have an understanding of the manufacturer’s operating instructions and warnings before using this pressure washer. Warning information should be emphasized and understood. If the operator is not fluent in English, the manufacturer’s instructions and warnings shall be read to and discussed with the operator in the operator’s native language by the purchaser/owner, making sure that the operator comprehends its contents. Owner and/or user must study and maintain for future reference the manufacturer’s instructions.

Symbols on the machine



The high pressure jet may not be directed at persons, animals, live electrical equipment or at the appliance itself. Protect the appliance against frost.



Risk of burns on account of hot surfaces!



Risk of poisoning! Do not breathe in the exhaust fumes.

Kärcher Customer Support Australia

Call: **1 800 675 714** for help or visit our website:

www.karcher.com.au

Please take a moment to register your pressure washer online at:

www.karcher.com.au

Kärcher Customer Support New Zealand

Call: **0800 5272437** for help or visit our website:

www.karcher.co.nz

MODEL OVERVIEW

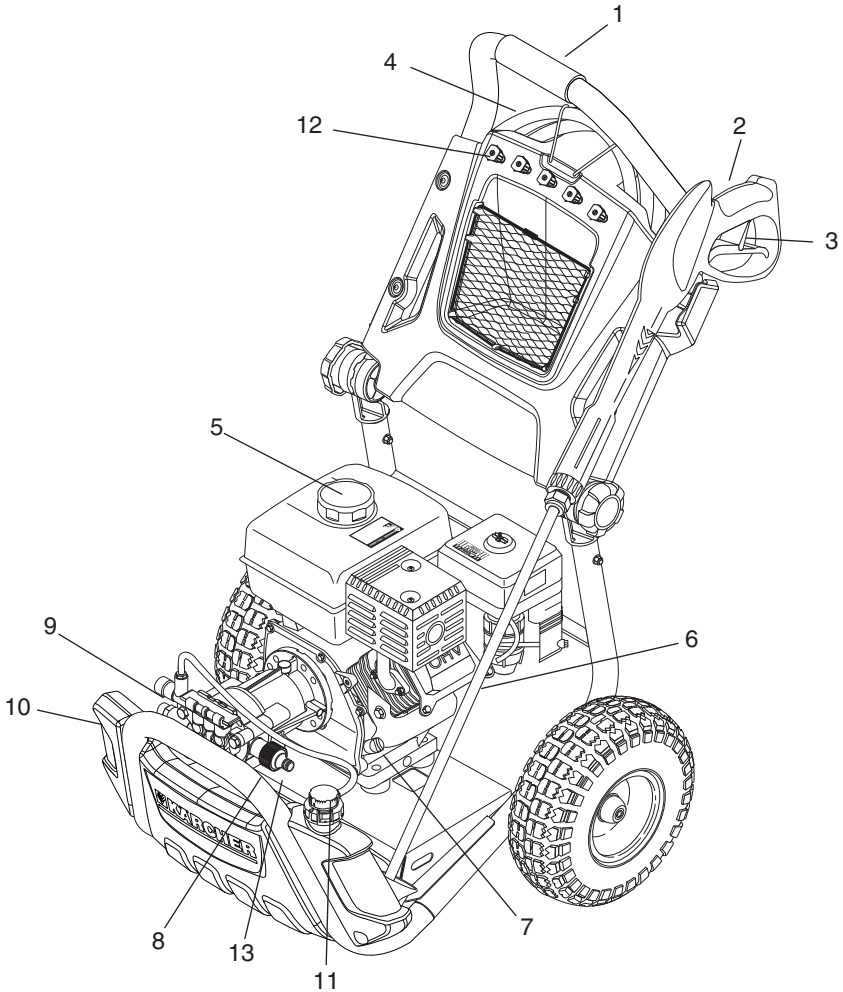

- | | |
|----------------------------|---|
| 1. Handle | 8. Water Inlet With Garden Hose Connector |
| 2. Trigger Gun | 9. Quick Connect High Pressure Outlet |
| 3. Trigger Gun Safety Lock | 10. Detergent Tank |
| 4. High Pressure Hose | 11. Detergent Metering Valve and Detergent Suction Tube |
| 5. Gas Tank | 12. Quick Connect Nozzles |
| 6. Spray Wand | 13. Garden Hose Adapter |
| 7. Dipstick | |

For Engine Details See Engine Manual

IMPORTANT SAFETY INSTRUCTIONS

- Read the operating instructions of the engine manufacturer before start-up and follow the safety instructions carefully.

WARNING

When using this product, basic precautions should always be followed, including the following:

- Read all instructions before using product.
- To reduce the risk of injury, close supervision is necessary when a product is used near children.
- Know how to stop the product and bleed pressures quickly. Be thoroughly familiar with the controls.
- Stay alert – watch what you are doing.
- Do not operate when fatigued or under the influence of alcohol or drugs.
- Keep operating area clear of all persons.
- Do not overreach or stand on unstable support. Keep good footing and balance at all times.
- Wear safety goggles and ear protection.
- Follow the maintenance instructions specified in the manual.
- To avoid risks, all repairs and replacement of spare parts should only be carried out by trained personnel.

WARNING

Risk of Injection or Injury – Do Not Direct Discharge Stream At Persons.

- High pressure jets can be dangerous if misused. The jet must not be directed at persons, animals, electrical devices, or the unit itself.



DANGER

Do not spray electrical connections, electrical outlets or fixtures.

WARNING

Risk Of Explosion – Do not spray flammable liquids. Operate only where open flame or torch is permitted.

- Do not use acids, solvents, or any flammable or alkaline material in this product. These products can cause physical injuries to the operator and irreversible damage to the machine.

WARNING

Gun Kicks Back – Hold with both hands.

- The Trigger Gun Safety Lock prevents the trigger from accidentally being engaged. This safety feature must be engaged when replacing nozzles or not in use.

WARNING

The engine exhaust from this product contains chemicals known to the State of California to cause cancer, birth defects or other reproductive harm. Operation of this equipment may create sparks that can start fires around dry vegetation. A spark arrestor may be required. Operator should contact local fire agencies for laws or regulations.

CAUTION

Risk of Asphyxiation – Use this product only in a well ventilated area.

- Operate and fuel machine in a well ventilated area, free of devices featuring an open pilot or flame such as boilers, water heaters, etc.

CAUTION

Risk of Fire – Do not add fuel when the product is operating or still hot.

CAUTION

Risk of fire - Do not put container with flammables products into the nozzle holder.

- Do not operate if fuel has been spilled. Instead, move machine to different location and avoid creating sparks.
- This machine has hot surfaces which can cause burns. Operate in a safe environment and away from children.
- Do not touch hot surfaces or allow accessories to contact hot surfaces.
- Do not leave machine running unattended.
- Avoid tipping machine on its side.

SAVE THESE INSTRUCTIONS

WATER SUPPLY (Cold Water Only)

⚠ CAUTION

When connecting to water supply mains, local regulations of your municipal water company must be observed. In some areas connecting directly to public drinking water supply may require a backflow prevention device. This is to ensure that there is no feedback of chemicals into the water supply. Use a suitable system separator manufactured by KÄRCHER; or, as an alternative, a system separator as per EN 12729 Type BA. Water flowing through a system separator is considered non-drinkable.



- Garden hose must be at least 16 mm diameter.







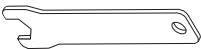

- Flow rate of water supply must not fall below 9.5 L/Min.
- Flow rate can be determined by running the water for one minute into an empty 19 L container.
- The water supply temperature must not exceed 104°F/40°C.
- Never use the pressure washer to draw in water contaminated with solvents, e.g. paint thinners, gasoline, oil, etc.
- Always prevent debris from being drawn into the unit by using a clean water source. Use additional water filter.
- Do not operate pressure washer without the water turned on.

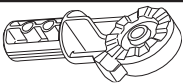
ASSEMBLY INSTRUCTIONS

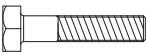
Required Tools (included)

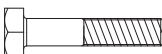
Description	
7/16" (or 11mm) Wrench Stamped	

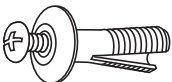
Hardware (included)

	Description	Purpose	Illustration	Qty
A	Joint	Joint Assembly		4
B	Nut 6 mm (1/4")	Joint Assembly		4
C	Bolt 6 mm (1/4")	Joint Assembly	 	4
D	Bolt 9.5 mm (3/8")	Joint Assembly	 	2
E	Knob	Joint Assembly		2
F	Anchor Rivet	Nozzle Holder Assembly		4
G	Wand	Wand Assembly		1

	Description	Purpose	Illustration	Qty
H	Tank	Detergent tank		1
I	Spray Gun	Spray Gun Assembly		1
J	Quick Connect Nozzle Kit (5 pc.)	Nozzles Kit Assembly		1

Assembling

→ STEP 1:

Insert joints (A) into handle. Use one 6 mm (1/4") bolt (C) and tighten with one 6 mm (1/4") nut (B) on each side. Hand tighten.

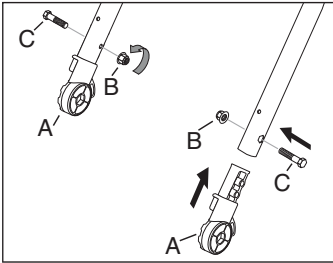

→ STEP 2:

Attach the handle to the frame of the pressure washer. Align holes, insert one 9.5 mm (3/8") bolt (D), and tighten the knob (E) on each side.

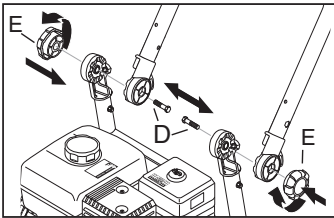

→ STEP 3:

Mount the detergent tank (H) to the bumper, insert anchor rivets (F) and install them by using a phillips screwdriver.

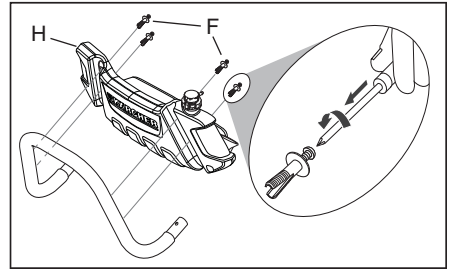

→ STEP 4:

Attach the bumper to the pressure washer frame pushing the button snap located at the bumper bottom.

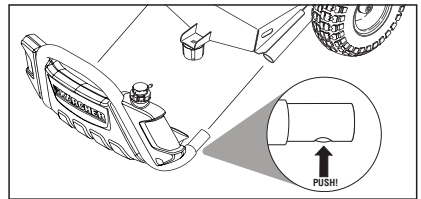

→ STEP 5:

Place the quick connect nozzles (J) in the nozzle holder.

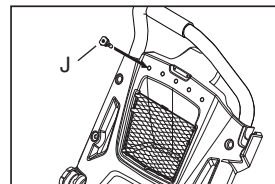

Assembling

→ STEP 6:

Attach the wand to the spray gun.
Push the wand (G) into the trigger gun (I) and then thread the connection until tight.

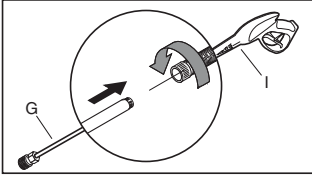

→ STEP 7:

Place the Spray Gun (I) into the Gun Holder and the Wand (G) into the Wand Holder.

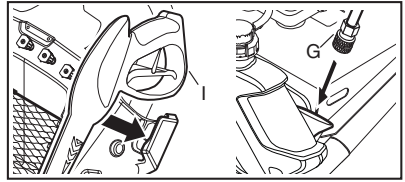

OPERATING INSTRUCTIONS

→ STEP 1:

Pull the spring-loaded collar of the wand back to insert your choice of quick connect nozzle.

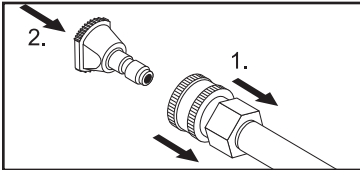

Release the collar and push the nozzle until the collar clicks.

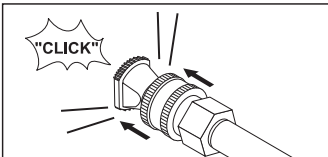

⚠ CAUTION

High pressure in nozzle area.
Risk of injury caused by improperly locked nozzle.

- Make sure you hear a "click" when inserting the nozzle tip into the wand.
- Pull the nozzle to make sure it is seated properly before operating your unit.

→ STEP 2:

Pull back the spring loaded collar at the spray gun and insert the high pressure hose.

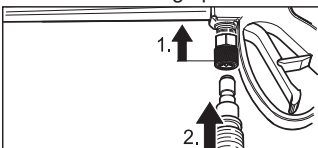

Release the collar and push the nozzle until the collar clicks.

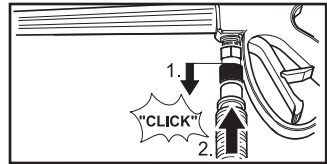

⚠ CAUTION

High pressure in quick connect area.
Risk of injury caused by improperly locked high pressure hose.

- Make sure you hear a "click" when inserting the high pressure hose into the quick connection.
- Pull the high pressure hose to make sure it is seated properly before operating your unit.

⚠ CAUTION

Engine shipped without oil. Before starting engine, fill with oil. Do not over-fill. Do not run the engine with a high or low oil level as this can cause engine damage.

If you have further questions regarding the engine, please refer to the engine manual included with the unit.

⚠ CAUTION

Never start engine while handlebar is folded.

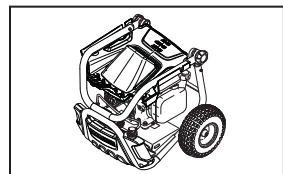

OPERATING INSTRUCTIONS

⚠ CAUTION

Allow the engine to cool down before folding down the handlebar for storage.

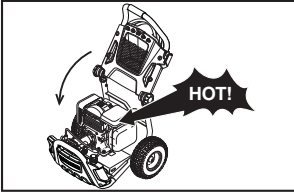

➔ **STEP 3:**

Check oil level. Oil level should always be between the "FULL" and "ADD" or "MAX" and "MIN" marks on the dipstick as shown in the picture below.

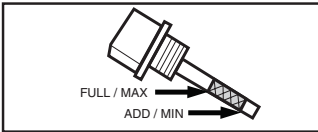

Be sure the machine is level when checking the oil level. (Refer to the engine's operating manual for seasonal grades).

We recommend that the oil be changed after the first 5 hours of use, then once every 50 hours.

➔ **STEP 4:**

Fill gas tank with unleaded gasoline.

Do not use leaded gasoline.

Do not add oil to the gasoline.

➔ **STEP 5:**

Pull back the spring loaded collar at the high pressure outlet and insert the high pressure hose.

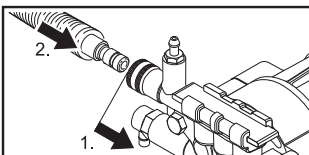

Release the collar and push the high pressure hose until the collar clicks.

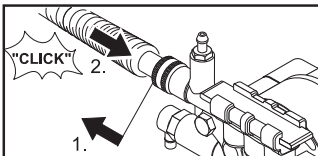

⚠ CAUTION

High pressure in quick connect area.

Risk of injury caused by improperly locked high pressure hose.

- Make sure you hear the "click" when inserting the high pressure hose into the quick connection.
- Pull the high pressure hose to make sure it is seated properly before operating your unit.

➔ **STEP 6:**

Connect garden hose to unit's water inlet.

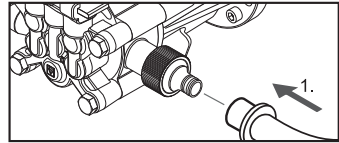

➔ **STEP 7:**

Connect garden hose to the cold water source and turn water completely on.

Do not use hot water.

➔ **STEP 8:**

Unlock the trigger gun safety lock. Trigger the gun to eliminate trapped air, wait for a steady flow of water to emerge from the spray nozzle.

➔ **STEP 9:**

Open fuel valve. Pull the choke rod to the ON position (on a warm engine, leave the choke rod in the OFF position).

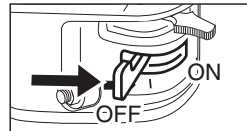

➔ **STEP 10:**

Move the engine stop switch to the ON position.

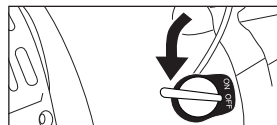

OPERATING INSTRUCTIONS

→ STEP 11:

Pull the starter handle. If the engine fails to start after 3 pulls, squeeze the trigger gun to release pressure, and repeat step.

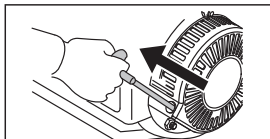

After the engine warms up enough to run smoothly, move choke rod to OFF position.

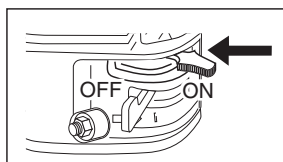

For engine details see engine manual.

USING THE ACCESSORIES

Quick connect nozzles

The color-coded quick connect nozzles provide a wide array of spray widths from 0° to 65° and are easily accessible when placed in the convenient nozzle holder.

0° spray angle = Red nozzle

For particularly stubborn accumulation of grime. **Not recommended** for soft materials like sidings, decks, painted surfaces, cars.

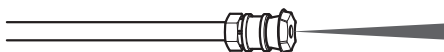

15° spray angle = Yellow nozzle

For dirt accumulation over a surface.

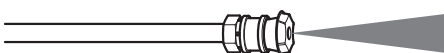

25° spray angle = Green nozzle

For dirt accumulation over a large surface.

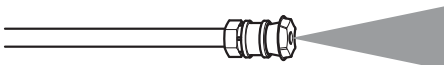

40° spray angle = White nozzle

For moderate dirt accumulation over a large surface.

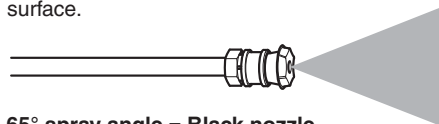

65° spray angle = Black nozzle

For operating with detergents or cleaning with low pressure.

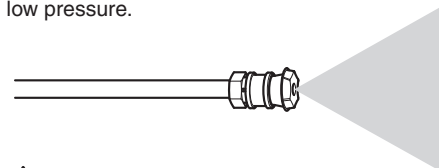

⚠ CAUTION

High pressure in nozzle area. Risk of injury caused by improperly locked nozzle.

- Make sure you hear the "click" when inserting the nozzle tip into the quick connection.
- Pull the nozzle to make sure it is seated properly before operating your unit. (See OPERATING INSTRUCTIONS: Step 1)

⚠ WARNING

To avoid serious injury never point spray nozzle at yourself, other persons or animals.

WORKING WITH DETERGENTS

Detergents can only be applied with the black detergent nozzle.

→ STEP 1:

Install the black detergent nozzle for detergent application at low pressure.

→ STEP 2:

Fill the detergent tank with Kärcher detergent. Close the detergent tank with the detergent mattering cap.

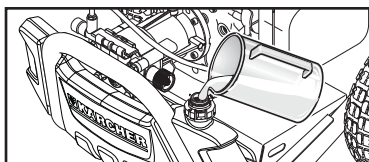

WORKING WITH DETERGENTS

→ STEP 3:

Connect detergent suction tube by firmly inserting into pressure washer's pump.

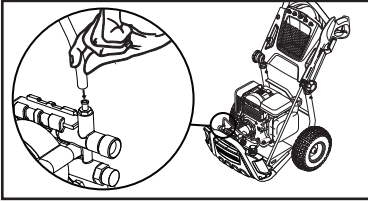

→ STEP 4:

Adjust the detergent metering valve to the desired dosage.

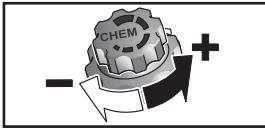

→ STEP 5:

With the engine running, pull trigger to operate unit. Liquid detergent is drawn into the unit and mixed with water.

Apply detergent to work area.

Do not allow detergent to dry on surface.

→ STEP 6:

Always draw fresh water through the detergent suction tube when the cleaning job is done, to rinse/flush any remaining detergents from the injection system.

For best results see *Cleaning Tips* for specific information on how to clean different surfaces.

Detergents

⚠ CAUTION

This unit has been designed for use with cleaning detergents recommended by the manufacturer.

The use of other cleaning detergent may affect the operation of the machine and void the warranty.

Always Use Kärcher Detergent for Best Results

Kärcher biodegradable detergents are specially formulated to protect the environment and your pressure washer. The special formula won't clog the suction tube filter and will protect the internal parts of the pressure washer for a longer life. For Kärcher Detergents, check your retailer or visit our website:

www.karcher.com.au

www.karcher.co.nz

⚠ CAUTION

Never use:

- Bleach, chlorine products or other corrosive chemicals
- Liquids containing solvents (i.e., paint thinners, gasoline, oils.)
- Tri-sodium phosphate products
- Ammonia products
- Acid-based products

These chemicals will harm the unit and will damage the surface being cleaned.

Use of these items will void the warranty.

TAKING A BREAK ...five minutes or more

→ STEP 1:

Move the engine stop switch to the OFF position. For engine details see engine manual.

→ STEP 2:

Release trigger and engage safety lock.

SHUTTING DOWN & CLEAN-UP

→ STEP 1:

If detergents have been used, remove detergent suction tube from container and insert into 3.78 liters of fresh water.

Siphon water at low pressure for one minute to clear the line of residual detergent.

→ STEP 2:

Move the engine stop switch to the OFF position. Close the fuel valve.

→ STEP 3:

Turn off the water source.

→ STEP 4:

Press trigger to release water pressure.

→ STEP 5:

Release trigger and engage gun safety lock.

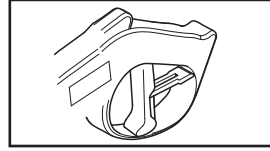

→ STEP 6:

Disconnect the garden hose from the water inlet on the unit.

→ STEP 7:

Disconnect the high pressure hose from the high pressure outlet. Store the high pressure hose in the nozzle holder assembly.

LONG TERM STORAGE

→ 1: Disconnect all water connections.

→ 2: Turn on the machine for a few seconds, until the water which had remained in the pump exits, turn off immediately.

→ 3: Do not allow high pressure hose to become kinked.

→ 4: Store the machine and accessories in a room which does not reach freezing temperatures. DO NOT store near furnace or other sources of heat as it may dry the pump seals.

⚠ CAUTION

Failure to follow the above directions will result in damage to the pump assembly and accessories and will void the warranty.

It is highly recommended to use Kärcher's Pump Guard (part number 9.558-998.0) before winter storage and during the cleaning season to protect the pump from freezing and premature wear.

MAINTENANCE INSTRUCTIONS

Kärcher pump

Initial Use

All Kärcher pumps ship with oil already inside direct from the factory. There is no need to add oil.

Pump Inspection

You should routinely make a visual inspection of the pressure washer's pump. If you notice oil leaking around the pump seals, you should take the pressure washer to a Kärcher-Authorised Service Centre for repair. (You can locate a service center in your area online at: www.karcher.com.au & www.karcher.co.nz).

Pump Maintenance

The pump on your Kärcher pressure washer does not require maintenance. Any attempts to service or alter the pump may damage your pressure washer and void your product warranty.

Engine

Carry out maintenance tasks for the engine according to the specifications provided in the operating instructions provided by engine manufacturer.

CLEANING TIPS

Deck Cleaning

(with or without detergent). Pre-rinse deck and surrounding area with fresh water. If using Kärcher Deck Wash, apply to surface at low pressure. For best results, limit your work area to smaller sections of approximately 2.3 square meters. Allow Deck Wash to remain on surface 1-3 minutes. Do not allow detergent to dry on surface. Rinse at high pressure in a long sweeping motion keeping the spray nozzle approximately 8 - 15 cm from the cleaning surface. Always clean from top to bottom and from left to right. When moving on to a new section of the cleaning surface, be sure to overlap the previous section to eliminate stop marks and ensure a more even cleaning result.

House Siding

(with or without detergent). Pre-rinse cleaning surface with fresh water. If using Kärcher Pressure Wash, apply to surface at low pressure (for best results, limit your work area to sections of approximately 1.9 meters and always apply detergent from bottom to top). Allow detergent to remain on surface 1-3 minutes. Do not allow detergent to dry on surface, if surface appears to be drying, simply wet down surface with fresh water. If needed, use special wash brush attachment (not included) to remove stubborn dirt. Rinse at high pressure from top to bottom in an even sweeping motion keeping the spray nozzle approximately 15 cm from the cleaning surface.

Cement Patios, Brick and Stone

(with or without detergent). Pre-rinse cleaning surface with fresh water. If using Kärcher Pressure Wash or Degreaser, apply to surface at low pressure. For best results, limit your work area to smaller sections of approximately 2.3 square meters. Allow Pressure Wash or Degreaser to remain on surface 1-3 minutes. Do not allow detergent to dry on surface. Rinse at high pressure in a sweeping motion keeping the spray nozzle approximately 8 - 15 cm inches from the cleaning surface. Always clean from top to bottom and from left to right. For removing extremely stubborn stains, use a Dirt-Blaster® Spray Nozzle (sold separately).

Cars, Boats & Motorcycles

(with or without detergent). Pre-rinse vehicle with fresh water. If using Kärcher Vehicle Wash, apply to surface at low pressure. For best results, clean one side of vehicle at a time and always apply detergent from bottom to top, do not allow detergent to dry on surface. If needed, use special wash brush attachment (not included) to remove stubborn dirt. Rinse at high pressure in a sweeping motion keeping the spray nozzle approximately 15 - 20 cm from the cleaning surface (distance should increase when rinsing pin-striping or other sensitive surfaces). Always clean from top to bottom and from left to right. For best results, wipe surface dry with a chamois or soft dry cloth.

Barbecue Grills, Outdoor Power Equipment & Gardening Tools

(with or without detergent). Pre-rinse cleaning surface with fresh water. If using Kärcher Pressure Wash or Degreaser, apply detergent at low pressure. Allow Pressure Wash to remain on surface 1-3 minutes. Do not allow detergent to dry on surface. Rinse at high pressure keeping the spray nozzle approximately 8 - 15 cm from the cleaning surface. For removing extremely stubborn dirt, it may be necessary to move the spray nozzle even closer to the surface for greater dirt cutting action.

Patio & Lawn Furniture

(with or without detergent). Pre-rinse furniture and surrounding area with fresh water. If using Pressure Wash, apply to surface at low pressure. Allow Pressure Wash to remain on surface 1-3 minutes. Do not allow detergent to dry on surface. If needed use special Wash Brush Attachment (not included) to remove stubborn dirt. Rinse at high pressure in a sweeping motion keeping the spray nozzle approximately 8 - 15 cm from the cleaning surface. For best results, clean from top to bottom and from left to right.

CLEANING TIPS

Recommendations

- Before cleaning any surface an inconspicuous area should be cleaned to test spray pattern and distance for maximum cleaning results.
- If painted surfaces are peeling or chipping, use extreme caution as pressure washer may remove the loose paint from the surface.
- When using on surfaces which might come in contact with food, flush surfaces with plenty of drinking water.
- For additional cleaning tips, visit our website at www.karcher.com.au or www.karcher.co.nz

Optional Accessories

Optional accessories are available to further enhance your cleaning capabilities. These accessories are accurate as of the printing date of this manual. Please check our website:

www.karcher.com.au & www.karcher.co.nz for up-to-date information.

- Extension Hose
- DirtBlaster® Spray Nozzle
- Universal Wash Brush Kit
- T350 Deck and Driveway Cleaner

TROUBLESHOOTING

CAUTION

Remove the spark plug cable to prevent accidental ignition of the engine before making any repair

Symptom	Cause	Solution
ENGINE WILL NOT START	No gasoline	Fill gas tank
	Choke is not in the correct position	Slide choke lever out to closed position
	Water pressure built up in the machine	Squeeze the trigger to release the pressure
	For additional engine problems refer to the engine manual.	
UNIT DOES NOT REACH HIGH PRESSURE	Diameter of garden hose is too small	Replace with a 16 mm diameter hose or larger garden hose
	Water supply is restricted	Check garden hose for kinks, leaks and blockage
	Not enough inlet water supply	Turn water on full force. Check garden hose for kinks, leaks or blockage.
	Water inlet filter is clogged	Remove filter and rinse out in warm water
	Black detergent nozzle is attached	Remove black detergent nozzle and attach high pressure nozzle
OUTPUT PRESSURE VARIES HIGH AND LOW	Not enough inlet water supply.	Turn water on full force. Check garden hose for kinks, leaks or blockage
	Pump is sucking air	Check that hoses and fittings are air tight. Turn off machine and purge pump by squeezing trigger gun until a steady flow of water emerges through the nozzle
	Water inlet filter is clogged	Remove filter and rinse out in warm water
	Spray nozzle is obstructed	Blow out or remove debris with a fine needle
	Calcified gun, hose or spray wand	Run distilled vinegar through detergent suction tube.

TROUBLESHOOTING

Symptom	Cause	Solution
NO DETERGENT	Detergent suction tube not properly connected to the machine	Check connection
	Detergent is too thick	Dilute detergent, for best results use Kärcher detergent
	Filter on detergent suction tube is clogged	Run warm water through filter to remove debris
	Damaged or clogged detergent suction tube	Remove obstruction or replace detergent suction tube
	A high pressure nozzle is attached	Replace with black detergent nozzle
	Spray nozzle is obstructed	Blow out or remove debris with fine needle
GARDEN HOSE CONNECTION LEAKS	Loose fittings	Tighten fittings
	Missing/worn rubber washer	Insert new washer
SPRAY WAND LEAKS	Spray wand not properly attached	Turn the swivel nut of the gun clockwise until connection is tight
	Broken o-ring or plastic insert	Visit www.karcher-help.com or locate a service centre at www.karcher.com.au or www.karcher.co.nz
PUMP IS NOISY	Not enough gas or engine oil	Check that hoses and fittings are air tight. Turn off machine and purge pump by squeezing trigger gun until a steady flow of water emerges through the nozzle
WATER LEAKS FROM PUMP (UP TO 10 DROP PER MINUTE IS PERMISSIBLE)	Loose fittings	Check quick connect fittings
	Water seals are damaged or worn.	Visit www.karcher-help.com or locate a service centre at www.karcher.com.au or www.karcher.co.nz
	Thermal protection device is activated.	Thermal protection device will auto reset. Do not run pump for more than 5 minutes without spraying
OIL DRIP	Oil seals are damaged or worn	Visit www.karcher-help.com or locate a service centre at www.karcher.com.au or www.karcher.co.nz

If the symptom you are experiencing is not listed above, or if the provided solutions do not solve your issue, please visit our extensive online troubleshooting database at:

www.karcher.com.au or www.karcher.co.nz

A
Alfred Kärcher Ges.m.b.H.
Lichtblaustraße 7
1220 Wien
☎ (01) 250 600

AUS
Kärcher Pty. Ltd.
40 Koornang Road
Scoresby VIC 3179
☎ (03) 9765 - 2300

B / LUX
Kärcher N.V.
Industrieweg 12
2320 Hoogstraten
☎ B: 0900 10027
LUX: 0032 900 10027

BR
Kärcher Indústria e Comércio Ltda.
Av. Prof. Benedito Montenegro 419
CEP 13.140-000 - Paulínia - SP
☎ 0800 176 111

CDN
Kärcher Canada Inc.
6975 Creditview Road Unit #2
Mississauga, Ontario L5N 8E9
☎ 1-800-465-4980

CH
Kärcher AG
Industriestraße 16
8108 Dällikon
☎ 0844 850 863

CZ
Kärcher spol s r.o.
Modletice č.p. 141
251 01 Říčany u Prahy
☎ 0323 606 014

D
Alfred Kärcher GmbH & Co. KG
Service-Center Gissigheim
Im Gewerbegebiet 2
97953 Königheim-Gissigheim
☎ (07195) 903 2065

DK
Kärcher Rengøringsystemer A/S
Gejlhavegård 5
6000 Kolding
☎ 70 206 667

E
Kärcher S.A.
Pol. Industrial Font del Radium
Calle Doctor Trueta 6-7
08400 Granollers (Barcelona)
☎ 902 170 068

F
Kärcher S.A.S.
5 Avenue des Coquelicots
Z.A. des Petits Carreaux
94865 Bonneuil-sur-Marne
☎ (01) 43 996 770

FIN
Kärcher OY
Yrittäjätie 17
01800 Klaukkala
☎ 0207 413 600

GB
Kärcher(UK) Limited
Kärcher House
Beaumont Road
Banbury
Oxon, OX16 1TB
☎ 01295 752 200

GR
Kärcher Cleaning Systems A.E.
31-33, Nikitara str. &
Konstantinoupoleos str.
13671 Acharnes
☎ 210 - 2316 153

H
Kärcher Hungária Kft
Tormásrét ut 2.
2051 Biatorbágy
☎ (023) 530 640

HK
Kärcher Limited
Unit 10, 17/F.
APEC Plaza
49 Hoi Yuen Road
Kwun Tong, Kowloon
☎ (02) 357-5863

I
Kärcher S.p.A.
Via A.Vespucci 19
21013 Gallarate (VA)
☎ 848 - 99 88 77

IRL
Kärcher Limited
12 Willow Business Park
Nangor Road
Clondalkin Dublin 12
☎ (01) 409 77 77

KOR
Kärcher Co. Ltd. (South Korea)
Youngjae B/D, 50-1, 51-1
Sansoo-dong, Mapo-ku
Seoul 121-060
☎ 032-465-8000

MAL
Kärcher Cleaning
Systems Sdn. Bhd.
No. 8, Jalan Serindit 2
Bandar Puchong Jaya
47100 Puchong, Selangor
☎ (03) 5882 1148

MEX
Kärcher México, SA de CV
Av. Gustavo Baz No. 29-C
Col. Naucalpan Centro
Naucalpan, Edo. de México
C.P. 53000 México
☎ 01 800 024 13 13

N
Kärcher AS
Stanseveien 31
0976 Oslo
☎ 24 17 77 00

NL
Kärcher BV
Postbus 474
4870 AL Etten-Leur
☎ 0900-33 444 33

NZ
Kärcher Limited
12 Ron Driver Place
East Tamaki, Auckland
☎ (09) 274-4603

P
Neoparts - Com. e
Ind. Automóvel, S.A.
Av. Infante D. Henrique, Lote 35
1800-218 Lisboa
☎ 21 8558300

PL
Kärcher Sp. z o.o.
Ul. Stawowa 140
31-346 Kraków
☎ (012) 6397-222

PRC
Kärcher Cleaning Systems
Co., Ltd.
Part B, Building 30,
No. 390 Ai Du Road
Shanghai Waigaoqiao 200131
☎ (021) 5046-3579

RO
Kärcher Romania s.r.l.
Sos. Odaïi Nr. 439
013606 București
☎ 0372 709 001

RUS
ООО «Керхер»
109147, Москва
ул. Таганская, д.34, стр.3
☎ +7 495 228 39 45

S
Kärcher AB
Tagenevägen 31
42502 Hisings-Kärra
☎ (031) 577-300

SGP
Kärcher Asia Pacific Pte. Ltd.
5 Toh Guan Road East
#01-00 Freight Links
Express Distripark
Singapore 608831
☎ 6897-1811

SK
Kärcher Slovakia, s.r.o.
Beniakova 2
94901 Nitra
☎ 037 6555 798

TR
Kärcher Servis Ticaret A.S.
9 Eylül Mahallesi
307 Sokak No. 6
Gaziemir / Izmir
☎ (0232) 252-0708

TWN
Kärcher Limited
5F/6, No.7
Wu-Chuan 1st Rd
Wu-Ku Industrial Zone
Taipei County
☎ (02) 2299-9626

UA
Kärcher Ukraine
Kilzeva doroga, 9
03191, Kyiv
☎ (044) 594 75 75

UAE
Kärcher FZE
Jebel Ali Free Zone
RA 8, XB 1, Jebel Ali, Dubai
☎ (04) 8836-776

USA
Kärcher North America
750 W Hampden Ave.
Suite 400
Englewood, CO 80110
☎ 877-527-2437

ZA
Kärcher (Pty.) Limited
144 Kuschke Street
Meadowdale
Edenvale 1614
☎ (011) 574-5360



www.kaercher.com