

Operating Instructions

Before first use of the unit
read these operating instructions
and act in accordance with them.

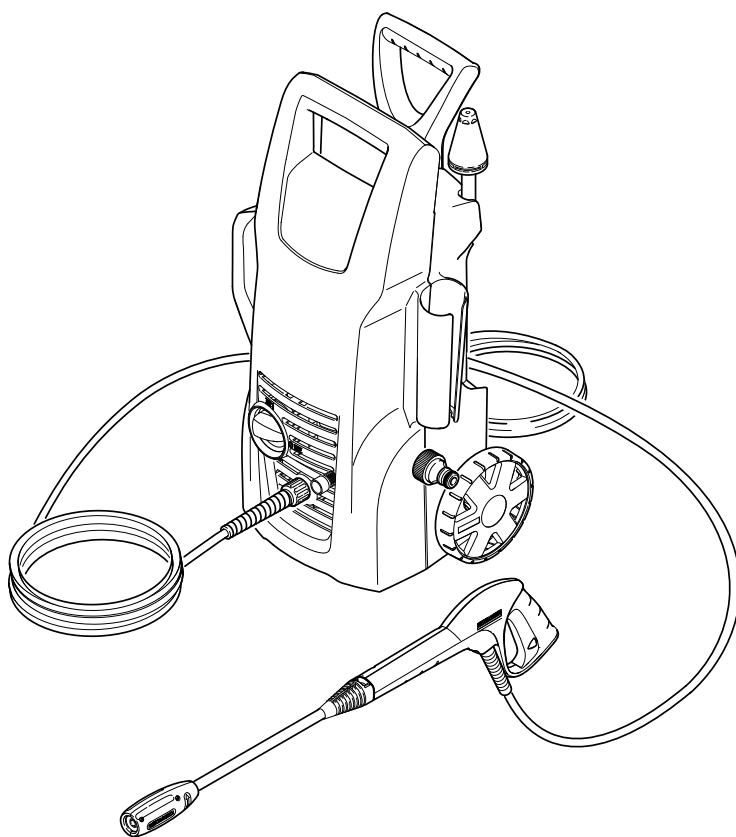



Contents

General information	2
Safety instructions	3
Operation	4
Maintenance and care	8
Troubleshooting	8
Helpline	9
Technical specifications	10
CE declaration	10
Spare Parts	11

General information

Dear Customer,

  Please read and comply with these original operating instructions prior to the initial operation of your appliance and store them for later use or subsequent owners.

Hazard levels

Danger

Immediate danger that can cause severe injury or even death.

Warning

Possible hazardous situation that could lead to severe injury or even death.

Caution

Possible hazardous situation that could lead to mild injury to persons or damage to property.

Proper Use

This high-pressure cleaner is designed for domestic use only:

- to clean machines, vehicles, buildings, tools, facades, terraces, garden equipment etc. using a high-pressure water jet (and detergents if required).
- with accessories, replacement parts and detergents approved by KÄRCHER. Observe the instructions provided with these detergents.

Environmental protection



The packaging material can be recycled. Please do not place the packaging into the ordinary refuse for disposal, but arrange for the proper recycling.



Old appliances contain valuable materials that can be recycled. Please arrange for the proper recycling of old appliances. Please dispose your old appliances using appropriate collection systems.

Notes about the ingredients (REACH)

You will find current information about the ingredients at:

<http://www.karcher.de/de/unternehmen/umweltschutz/REACH.htm>

High pressure hose

The high pressure hose is specially constructed with reinforced walls to handle water pressure up to 11 MPa (1600 psi) - it can be easily damaged and should be stored carefully.

- *Do not kink.*
- *Do not drive vehicles over the hose.*
- *Do not expose the hose to sharp edges or corners.*

Misuse will lead to ballooning or premature failure and will invalidate warranty.

Safety Devices

Caution

Safety devices protect the user and must not be modified or bypassed.

Power switch

The appliance switch prevents unintentional operation of the appliance.

Lock trigger gun

This lock locks the lever of the trigger gun and prevents the inadvertent start of the appliance.

Overflow valve with pressure switch

If the lever on the trigger gun is released the pressure switch turns off the pump, the high-pressure jet is stopped. If the lever is pulled the pump is turned on again.

Safety instructions

⚠ Danger

- Never touch the mains plug and the socket with wet hands.
- The appliance must not be used if the power cord or important parts of the appliance, e.g. high-pressure hoses, trigger gun or safety devices are damaged.
- Check the power cord and mains plug for damage before every use. If the power cord is damaged, please arrange for it to be replaced immediately by an authorised repair agent or a skilled electrician
- Check the high-pressure hose for damage before every use. Please arrange for the immediate replacement of a damaged high-pressure hose.
- The appliance may not be used in areas where a risk of explosion is present.
- If the appliance is used in hazardous areas (e.g. filling stations) the corresponding safety provisions must be observed.
- High-pressure jets can be dangerous if improperly used. The jet must not be directed at persons, animals, live electrical equipment or at the appliance itself.
- The high-pressure jet must not be directed at other persons or directed by the user at him/herself to clean clothing or footwear.
- Never use the appliance to clean objects containing hazardous substances (e.g. asbestos).
- Vehicle tyres or tyre valves are susceptible to damage from the high-pressure jet and may burst. The first indication of this is a discolouration of the tyre. Damaged vehicle tyres/tyre valves are highly dangerous. Ensure that a distance of at least 30 cm is observed when cleaning with the jet!
- Never draw in fluids containing solvents or undiluted acids and solvents! This includes petrol, paint thinner and heating



oil. The spray mist thus generated is highly inflammable, explosive and poisonous. Do not use acetone, undiluted acids and solvents as they are damaging to the materials from which the appliance is made.

⚠ Warning

- The mains plug and the coupling of an extension cable must be watertight and must never lay in the water.
- Unsuitable extension cables can be hazardous. Only use extension cables outdoors which have been approved for this purpose and labelled with a sufficient cable cross-section:
1 - 10 m: 1.5 mm²; 10 - 30 m: 2.5 mm²
- Always fully unroll electrical cables from the cable drum.
- High-pressure hoses, fixtures and couplings are important for the safety of the appliance. Only use high-pressure hoses, fixtures and couplings recommended by the manufacturer.
- This appliance is not intended for use by persons with reduced physical, sensory or mental capabilities. The appliance must not be operated by children or persons who have not been instructed accordingly. Children should be supervised to prevent them from playing with the appliance.
- The operator must use the appliance correctly. When working with the appliance, he must consider the local conditions and pay due care and attention to other persons, in particular children, who are nearby.
- Do not use the appliance when there are other persons around unless they are also wearing safety equipment.
- Wear protective clothing and safety goggles to protect against splash back containing water or dirt.

Caution

- *Do not operate the appliance at temperatures below 0 °C.*
- *Observe a distance of at least 30 cm when using the jet to clean painted surfaces to avoid damaging paintwork.*
- *Never leave the appliance unattended when it is in operation.*
- *Make sure that the power cable or extension cables are not damaged by running over, pinching, dragging or similar. Protect the power cable from heat, oil, and sharp edges.*
- *All current-conducting parts in the working area must be protected against jet water.*
- *The appliance may only be connected to an electrical supply which has been installed in accordance with IEC 60364.*
- *The appliance may only be connected to alternating current. The voltage must correspond with the type plate on the appliance.*
- *For safety reasons, we recommend that you operate the appliance only via a earth-leakage circuit breaker (max. 30 mA).*
- *Cleaning operations which produce oily waste water, e.g. engine washes, underbody washes, may only be carried out using washing stations equipped with an oil separator.*
- *This appliance was designed to be used with detergents which are supplied or recommended by the manufacturer. The use of other detergents or chemicals may compromise the safety of the appliance.*

Operation

Description of the Appliance

The scope of delivery of your appliance is illustrated on the packaging. Check the contents of the appliance for completeness when unpacking.

In the event of missing accessories or any transport damage, please contact your dealer.

Illustrations on Page 5

- 1 High pressure connection
- 2 Detergent suction hose (with filter)
- 3 Appliance switch "0/OFF"/ „I/ON“
- 4 Storage for high-pressure hose
- 5 Carrying handle
- 6 Transport handle, adjustable height
- 7 Storage for spray lance
- 8 Storage for trigger gun
- 9 Mains cable with mains plug
- 10 Water connection
- 11 Bearing wheel
- 12 Coupling element for water connection
- 13 Trigger gun
- 14 High pressure hose
- 15 Lock trigger gun
- 16 Clamp for high pressure hose
- 17 Spray lance with Dirtblaster
- 18 Spray lance with pressure regulation (Vario Power)

Special accessories

Special accessories expand the possibilities of using your appliance. Please contact your KÄRCHER dealer for further information.

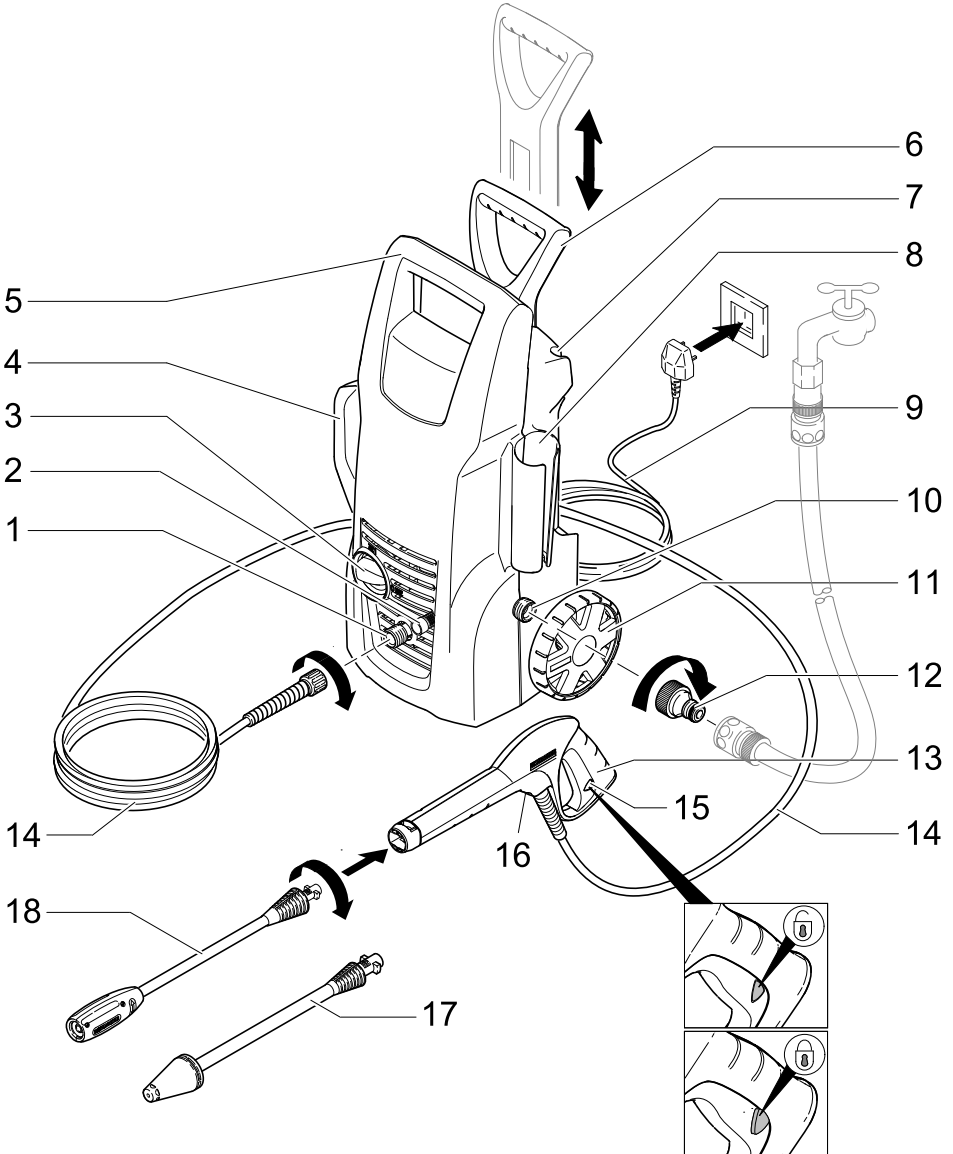
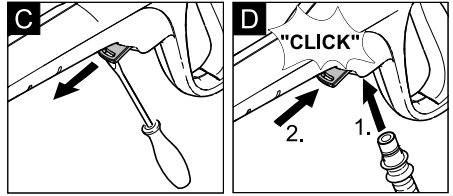
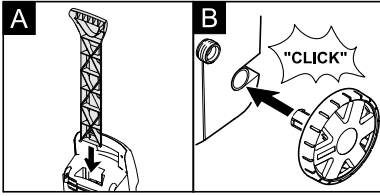

Before Startup

Mount loose parts delivered with appliance prior to start-up.

Illustrations on Page 5

- Illustration **A**
Insert the transport handle.
- Illustration **B**
Insert the transport wheels and lock them.
- Illustration **C**
Pull out the clamp for the high-pressure hose from the trigger gun (e.g. a small screwdriver).
- Illustration **D**
Connect high pressure hose to trigger gun.
Push the clamp in until it locks. Check the secure connection by pulling on the high-pressure hose.

Water supply

According to the applicable regulations, the appliance must never be used on the drinking water supply without a system separator. Use a suitable system separator manufactured by KÄRCHER; or, as an alternative, a system separator as per EN 12729 Type BA. Water flowing through a system separator is considered non-drinkable.



Note: Impurities in the water can damage the high-pressure pump and accessories. For protection, the use of the KÄRCHER water filter (optional accessory, order no. 4.730-059) is recommended.

Water supply from mains

Observe regulations of water supplier. For connection values, see type plate/technical data.

- Use a fibre-reinforced water hose (not included) with a standard coupling. (Minimum diameter 1/2 inch (13 mm), minimum length 7.5 m).
- Screw the coupling unit (supplied) to the water connection on the appliance.
- Push the water supply hose onto the coupling unit, then connect it to the water supply.

Start up

Caution

Dry runs lasting longer than two minutes lead to damages to the high pressure pump. If the appliance does not build up pressure within two minutes, switch it off and proceed as instructed in the Chapter "Help with faults".

- Connect the high pressure hose to the high pressure connection of the appliance.
- Push the spray lance into the trigger gun and fasten it by turning it through 90°.
- Completely open the water tap.
- Insert the mains plug into the socket.
- Turn on the appliance "I/ON".

Operation

⚠ Danger

The trigger gun is subjected to a recoil force when the water jet is discharged. Make sure that you have a firm footing and are also holding the trigger gun and spray lance firmly.

- Unlock the lever on the trigger gun.
- Pull on the lever of the trigger gun; the device will switch on.

Note: Release the lever of the trigger gun; the device will switch off again. High pressure remains in the system.

Spray lance with pressure regulation

Carrying out the most common cleaning tasks. The work pressure can be stagelessly regulated between "Min" and "Max".

- Release the lever on the trigger gun.
- Turn the spray lance to the desired position.

Spray lance with Dirtblaster

For particularly dirty items or areas. Not suitable for use with detergents.

Working with detergent

Please use exclusively KÄRCHER detergents and care products to carry out the respective cleaning task, as these were specifically developed for your appliance. The use of other detergents and care products may lead to premature wear and can invalidate your warranty claims. Please obtain information at your local dealer or request information directly from KÄRCHER.

- Pull detergent suction hose as far as is required out of the housing.
- Suspend end of detergent suction hose in a container filled with detergent.
- Use spray lance with pressure regulation (Vario Power).
- Turn the spray lance to "Mix" position.
Note: This will mix the detergent with the water stream.

Recommended cleaning method

- Spray the detergent sparingly on the dry surface and allow it to react, but not to dry.
- Spray off loosened dirt with the high-pressure jet.

Interrupting operation

- Release the lever on the trigger gun.
- Lock the lever on the trigger gun.
- During longer breaks (more than 5 minutes), also turn the appliance off using the "0/OFF" switch.
- Insert the trigger gun in its holder.

Finish operation

Caution

Only separate the high-pressure hose from the trigger gun or the appliance while there is no pressure in the system.

- After working with detergent, suspend detergent suction hose in a container filled with clear water, switch the appliance on for around 1 minute once the spray lance has been removed and rinse until water runs clear.
- Release the lever on the trigger gun.
- Turn off the appliance "0/OFF".
- Turn off tap.
- Detach the appliance from the water supply.
- Press the lever on the trigger gun to release any remaining pressure in the system.
- Lock the lever on the trigger gun.
- Pull out the mains plug.
- Stow away the mains cable, the high-pressure hose and accessory at the appliance.
- Insert the trigger gun in its holder.

Maintenance and care

⚠ Danger

Turn off the appliance and remove the mains plug prior to any care and maintenance work.

Maintenance

The appliance is maintenance-free.

Storage

Prior to longer periods of storage, e.g. in the winter:

- ➔ Completely drain all water from the appliance: Switch the appliance on with detached high-pressure hose and detached water supply (max. 1 minute) and wait, until no more water exits at the high-pressure connection. Turn off the appliance.
- ➔ Remove filter from suction hose for detergent and clean under running water.
- ➔ Pull out the sieve in the water connection using flat-nose pliers and clean under running water.

Frost protection

Caution

Protect the appliance and its accessories against frost.

The appliance and its accessories can get destroyed through frost if there are any water residues in them. To avoid damage to them:

- ➔ Store the appliance and the entire accessories in a frost-safe room.

Spare parts

Use only original KÄRCHER spare parts. You will find a list of spare parts at the end of these operating instructions.

Troubleshooting

You can rectify minor faults yourself with the help of the following overview. If in doubt, please consult the authorized customer service.

⚠ Danger

Turn off the appliance and remove the mains plug prior to any care and maintenance work.

Repair works may only be performed by the authorized customer service.

Appliance is not running

- ➔ Pull on the lever of the trigger gun; the device will switch on.
- ➔ Check whether the voltage indicated on the type plate corresponds to the voltage of the mains supply.
- ➔ Check the mains connection cable for damages.

Pressure does not build up in the appliance

- ➔ Check setting at the spray lance.
- ➔ Appliance ventilation: Switch the appliance on with the high-pressure hose detached and operate (max. 2 minutes) until the water exits the high-pressure connection without bubbles. Switch off appliance and reconnect high-pressure hose.
- ➔ Check the water supply.
- ➔ Pull out the sieve in the water connection using flat-nose pliers and clean under running water.

Strong pressure fluctuations

- ➔ Clean high-pressure nozzle: Remove dirt and debris from the nozzle bore, using a needle and rinse through with water from the front.
- ➔ Check water flow quantity.

Appliance is leaking

- ➔ Slight leakage from the appliance pump is normal. If the leakage increases contact the authorized customer service.

No detergent infeed

- ➔ Use spray lance with pressure regulation (Vario Power).
Turn the spray lance to "Mix" position.
- ➔ Clean the detergent suction hose filter.
- ➔ Check the detergent suction hose for kinks.

Helpline

KÄRCHER UK Limited operate a helpline allowing customers to discuss any problems experienced with our products.

The helpline operates during normal business hours and may be busy at peak periods. If you have difficulty getting through we would ask that you try to contact us again later in the day.

The helpline number is 01295 752200, open from 8.30am to 5.00pm Monday to Friday.

It helps us if you have the model number and data plate details to hand before making your call so that we can assist you with your query more effectively.

Alternatively you may write to us at the address below:

KÄRCHER UK Ltd
Kärcher House
Beaumont Road
Banbury
Oxon, OX16 1TB

or E-mail us:

info@karcher.co.uk

Warranty

The warranty terms published by the relevant sales company are applicable in each country. We will repair potential failures of your appliance within the warranty period free of charge, provided that such failure is caused by faulty material or defects in manufacturing. In the event of a warranty claim please contact your dealer or the nearest authorized Customer Service centre. Please submit the proof of purchase.

Technical specifications

Power connection

Voltage 220-240 V
1~50/60 Hz

Connected load 1,6 kW

Mains fuse (slow-blow) 13 A

Protective class II

Protection class IP X5

Water connection

Max. feed temperature 40 °C

Min. feed volume 8 l/min

Feed pressure 0,2-1,2 MPa

Performance data

Working pressure 9 MPa

Max. permissible pressure 11 MPa

Water flow rate 5,5 l/min

Detergent flow rate 0,4 l/min

Recoil force of trigger gun 12 N

Hand-arm vibration
(ISO 5349) 0,8 m/s²

Sound pressure level 74 dB(A)

L_{pA} (EN60704-1)

Sound power level 88 dB(A)

L_{WA} (2000/14/EG)

Dimensions

Length 287 mm

Width 229 mm

Height 576 mm

Weight 4,9 kg

Subject to technical modifications!

CE declaration

We hereby declare that the machine described below complies with the relevant basic safety and health requirements of the EU Directives, both in its basic design and construction as well as in the version put into circulation by us. This declaration shall cease to be valid if the machine is modified without our prior approval.

Product: High-pressure cleaner

Type: 1.672-xxx

Relevant EU Directives

98/37/EC

2006/95/EC (to 28.12.2009)

2006/42/EC (from 29.12.2009)

2004/108/EC

2000/14/EC

Applied harmonized standards

EN 55014-1: 2006

EN 55014-2: 1997 + A1: 2001

EN 60335-1

EN 60335-2-79

EN 61000-3-2: 2006

EN 61000-3-3: 1995 + A1: 2001 + A2: 2005

EN 62233: 2008

Applied conformity evaluation method

Appendix V

Sound power level dB(A)

Measured: 87

Guaranteed: 88

The undersigned act on behalf and under the power of attorney of the company management.

H. Jenner
CEO

S. Reiser
Head of Approbation

Alfred Kärcher GmbH Co. KG

Alfred-Kärcher-Str. 28 - 40

D - 71364 Winnenden

Phone: +49 7195 14-0

Fax: +49 7195 14-2212



www.karcher.co.uk