

Binford 1650



High Pressure Washer Operator Manual

Overview	2
Precautions	3 - 4
Assembly Instructions	4
Operating Instructions	5
Using the accessories	6
Working with Detergents	7
Shut Down and Clean-Up	8
Taking a Break	8
Winterizing and Long-Term Storage	8 - 9
Cleaning Tips	9 - 10
Optional Cleaning Accessories	10
Troubleshooting	11-12

Specifications

Working Pressure	9000 kPa
.....	1300 PSI
Max. Pressure	1650 PSI
Max. Water volume	1.6 GPM
Voltage	120 V
Amp draw	13 AMPS

**Please keep the original box, packaging and receipt.
Before operating this unit, please read this manual thoroughly and retain it for future reference.**

OVERVIEW

For household use only!

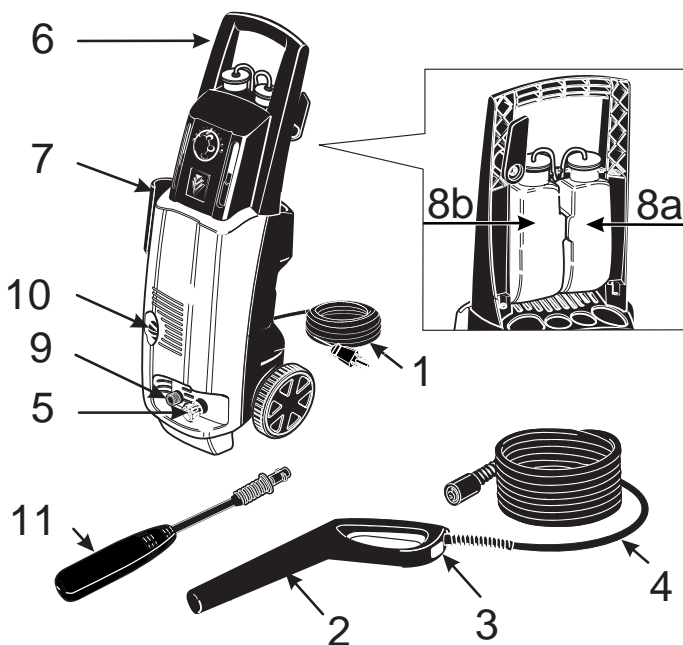

2

1. Power cord
2. Trigger gun
3. Trigger gun safety lock
4. High pressure hose
5. Water inlet with filter
6. Transport handle
7. Accessory compartment
- 8a. Detergent tank 1
- 8b. Detergent tank 2
9. High pressure outlet
10. On/Off switch
11. Quattro nozzle

NEVER!

- Never** point nozzle at people or animals.
- Never** drink alcohol or use drugs while operating this equipment.
- Never** operate while standing in water.
- Never** touch plug with wet hands.
- Never** let electrical connections rest in water.
- Never** operate pressure washer without the water turned on
- Never** use hot water

THE BEST ANTI-FREEZE PROTECTION IS PROVIDED BY USING AND STORING THE MACHINE IN SHELTERED SPACE

IMPORTANT PRECAUTIONS – Read First!



Safety Warnings

When using this product basic precautions should always be followed:

- Read all the instructions before using the product.
- High pressure jets can be dangerous if subject to misuse. The jet must not be directed at persons, animals, electrical devices, or the machine itself.
- To reduce the risk of injury, do not operate the machine near children.
- Learn how to stop the machine and release pressure quickly. Be thoroughly familiar with the controls.
- Stay alert — watch what you are doing.
- Wear safety goggles.
- Do not use acids, solvents, or any other flammable material in this product. These products can cause physical injuries to the operator and irreversible damage to the machine.
- Do not operate the product when fatigued or under the influence of alcohol or drugs.
- Do not stand on unstable surfaces. Stand with both feet balanced at all times.
- To reduce the risk of electrocution, keep all connections dry and off the ground. Do not touch plug with wet hands.
- The Trigger Gun Safety Lock PREVENTS the trigger from accidentally being engaged. This safety feature DOES NOT lock trigger in the on position.

WARNING

- DO NOT SPRAY ELECTRICAL APPARATUS AND WIRING.
- DO NOT USE WITH FLAMMABLE LIQUIDS AND TOXIC CHEMICALS
- INJECTION HAZARD: EQUIPMENT CAN CAUSE SERIOUS INJURY IF THE SPRAY PENETRATES THE SKIN. DO NOT POINT THE GUN AT ANYONE OR ANY PART OF THE BODY. IN CASE OF PENETRATION SEEK MEDICAL AID IMMEDIATELY.
- THIS SYSTEM IS CAPABLE OF PRODUCING 9000 KPA (1300 PSI). TO AVOID RUPTURE AND INJURY, DO NOT OPERATE THIS PUMP WITH COMPONENTS RATED LESS THAN 9000 KPA (1300 PSI) WORKING PRESSURE (INCLUDING BUT NOT LIMITED TO SPRAY GUNS, HOSE AND HOSE CONNECTIONS).
- BEFORE SERVICING, CLEANING OR REMOVING ANY PARTS, SHUT OFF POWER AND RELIEVE PRESSURE.

Extension Cords

Use a sufficient gauge:

Up to 25 ft. = 12/3 AWG.

25 to 50 ft. = 10/3 AWG.

Use only extension cords that are intended for outdoor use. These extension cords are identified by a marking "Acceptable for use with outdoor appliances; store indoors while not in use." Use only extension cords having an electrical rating not less than the rating of the product. Do not use damaged extension cords. Examine extension cord before using and replace if damaged. Do not abuse extension cord and do not yank on any cord to disconnect. Keep cord away from heat and sharp edges. Always disconnect the extension cord from the receptacle before disconnecting the product from the extension cord. If you are using an extension cord, it should always be completely unwound from the cable drum.

Grounding Instructions

This product must be grounded. If it should malfunction or breakdown, grounding provides a path of least resistance for electric current to reduce the risk of electric shock. This product is equipped with a cord having an equipment-grounding conductor and a grounding plug. The plug must be plugged into an appropriate outlet that is properly installed and grounded in accordance with all local codes and ordinances.

DANGER- Improper connection of the equipment-grounding conductor can result in a risk of electrocution. Check with a qualified electrician or service personnel if you are in doubt as to whether the outlet is properly grounded. Do not modify the plug provided with the product - if it will not fit the outlet, have a proper outlet installed by a qualified electrician. Do not use any type of adapter with this product.



Caution

- Follow the maintenance instructions specified in the manual.
- This machine has been designed for use with cleaning detergent supplied or recommended by the manufacturer. The use of other cleaning detergents may affect the operation of the machine and void the warranty.

IMPORTANT PRECAUTIONS – continued

Water Supply (Cold Water Only)

- Water hose must be at least 1/2 inch or 5/8 inch in diameter.
 - Flow rate of water supply must not fall below 2 GPM (gallons per minute).
 - Flow rate can be determined by running the water for one minute into an empty 5-gallon container.
 - The water supply temperature must not exceed 104°F/40°C.
- Never use the pressure washer to draw in water contaminated with solvents, e.g. paint thinner, gasoline, oil, etc.

NOTE: Dirt in the feed water will damage the unit. To avoid this risk, we recommend fitting a water filter.

- Always prevent debris from being drawn into the unit by using a clean water source and an accessory water filter if required.

Save these instructions!

ASSEMBLY INSTRUCTIONS

4

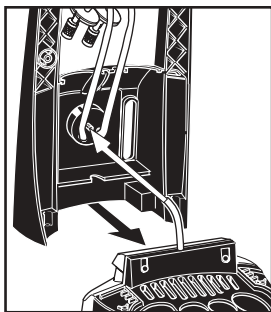

Step 1

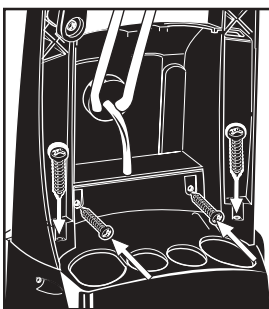

Step 2



Step 3

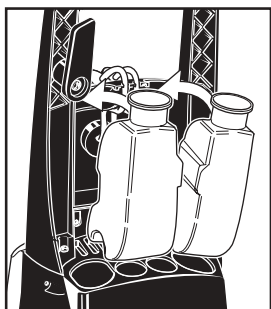

Step 4

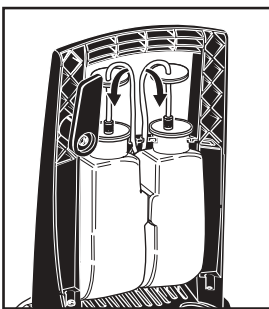

Step 5

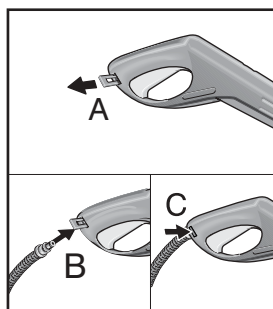

Step 6

Pull out the locking slide from the right side of the trigger gun handle (A), and insert the small end of the high pressure hose into place (B). Push the locking slide back into the trigger gun to lock the hose in position (C).

OPERATING INSTRUCTIONS

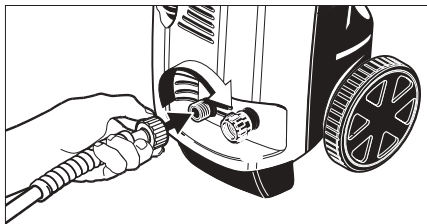

Step 1

Connect the high pressure hose to the high pressure outlet.

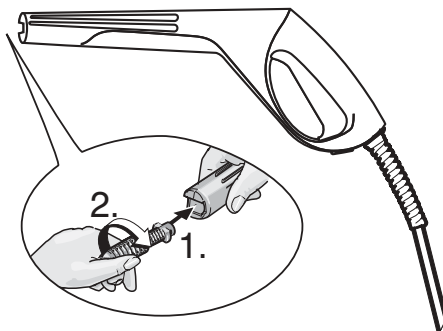

Step 2

Insert the quattro nozzle to the trigger gun. Press in against the spring tension and twist into the locked position.

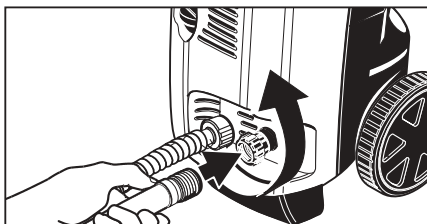

Step 3

Connect the garden hose to the water inlet.

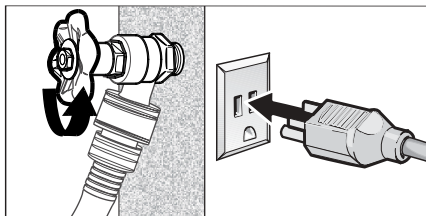

Step 4

Connect garden hose to the cold water source and turn water on completely. Plug the power cord into the power outlet.

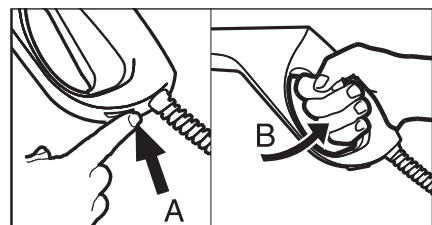

Step 5

Unlock the lock of the trigger gun (A). Trigger the gun (B) to eliminate trapped air, wait for a steady flow of water to emerge from the spray nozzle.



Step 6

Turn on the pressure washer (I). **The motor starts only if the trigger of the gun is pulled and shuts off when the trigger is released.**

USING THE ACCESSORIES

Quattro Nozzle

Selecting the jet

Release the trigger of the handgun.

Rotate the nozzle head until the symbol is aligned with the marking on the spray lance.

Note: The marking on the spray lance must be up during operation.



Warning

TO AVOID SERIOUS INJURY, NEVER POINT SPRAY NOZZLE AT YOURSELF, OTHER PERSONS OR ANIMALS

6



High pressure
pencil jet
cleaning



High pressure
fan jet
cleaning



Rotating jet for
maximum dirt
cutting action



Low pressure
fan jet for
detergent
injection

WORKING WITH DETERGENTS

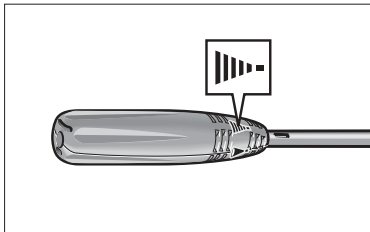

Step 1

Turn Quattro Nozzle to Low pressure position. Rotate the spray lance in the direction of "▶" until reaching the stop.

Note: No detergent in high-pressure mode

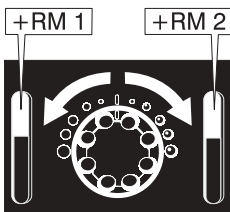

Step 3

Adjusting the detergent dosing valve to the desired dosage.

- Turn to the left: Meter detergent from container 1.
- Turn to the right: Meter detergent from container 2.

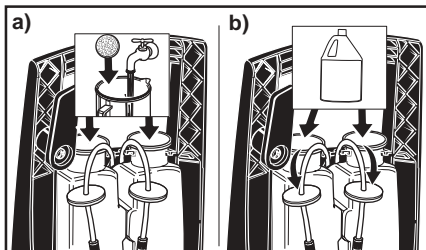

Step 2

- a) Fill the Detergent Tanks (No.8a, No.8b) with the selected detergent, ensuring it is the correct concentration (read recommended dosage on label) **or**
- b) Fill the Detergent Tank with Ready To Use detergent.

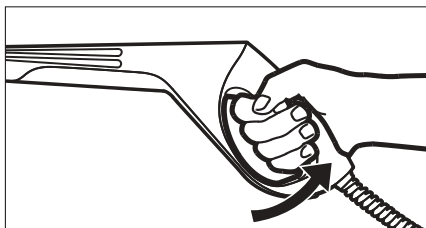

Step 4

Turn on the pressure washer. Pull trigger to operate unit: Liquid detergent is drawn into the unit and mixed with water. Apply detergent to work area. Do not allow detergent to dry on surface.

For best results see Cleaning Tips on pages 9 & 10 for specific information on how to clean different surfaces.

Always Use Kärcher Detergents for Best Results.

Kärcher biodegradable detergents are specially formulated to protect the environment and your pressure washer. Special formula won't clog the suction tube filter and will protect the internal parts of the pressure washer for a longer life. For Kärcher detergents, check your retailer or call:

1-800-465-4980

The following Kärcher detergents are available:

- Pressure Wash
- Degreaser
- Deck + Fence Wash
- Vehicle Wash



Caution

Never use:

- Bleach, Chlorine products and other corrosive chemicals
- Liquids containing solvents (i.e., paint thinner, gasoline, oils)
- Trisodium phosphate products
- Ammonia products
- Acid-based products

These chemicals will harm the unit and will damage the surface being cleaned.

SHUTTING DOWN & CLEAN-UP

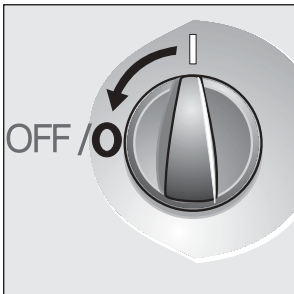

Step 1

Turn the switch to off (O) position and unplug cord from outlet.

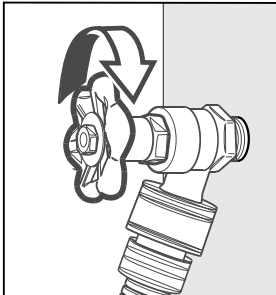

Step 2

Turn off the water source.



Step 3

Press trigger to release water pressure.

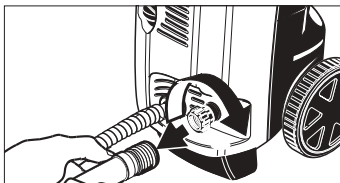

Step 4

Disconnect the garden hose from the water inlet on the unit.

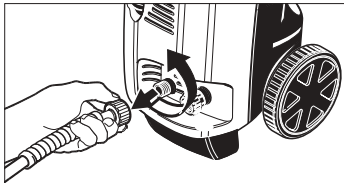

Step 5

Disconnect the high pressure hose from the high pressure outlet.

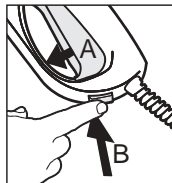

Step 6

Pull trigger down (A) and engage gun safety lock (B).

8

TAKING A BREAK... five minutes or more

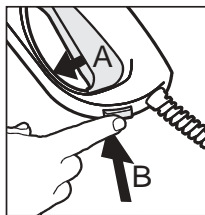

Step 1

Pull trigger down (A) and engage gun safety lock (B).

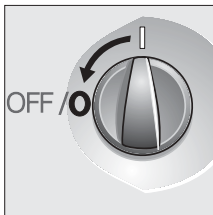

Step 2

Turn pressure washer to off (O) position.

WINTERIZING AND LONG-TERM STORAGE

1. Disconnect all water connections.
2. Turn on the machine for a **few seconds**, until the water which had remained in the pump exits. Turn off immediately.
3. Do not allow high pressure hose to become kinked.

4. Store the machine and accessories in a room which does not reach freezing temperatures. **DO NOT** store near furnace or other sources of heat as it may dry out the pump seals.

Caution: Failure to follow the above directions will result in damage to the pump assembly and accessories.

WINTERIZING AND LONG-TERM STORAGE – *continued*

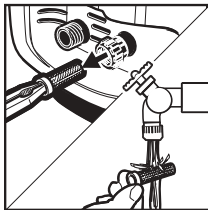

5) Cleaning the water inlet filter
Pull out the water inlet filter with flat-nose pliers and rinse out in warm water.

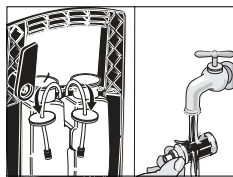

6) Cleaning the detergent inlet filter
Pull it out and rinse out in warm water.

Maintenance
The unit is maintenance-free.

CLEANING TIPS

Deck Cleaning (with or without detergent)

Pre-rinse deck and surrounding area with fresh water. If using Kärcher *Deck + Fence Wash*, apply to surface at low pressure. For best results, limit your work area to smaller sections of approximately 25 square feet. Allow *Deck Wash* to remain on surface 1-3 minutes. Do not allow detergent to dry on surface. Rinse at high pressure in a long sweeping motion keeping the spray nozzle approximately 3-6 inches from the cleaning surface. Always clean from top to bottom and from left to right. When moving on to a new section of the cleaning surface, be sure to overlap the previous section to eliminate stop marks and ensure a more even cleaning result.

Caution: Do not use rotary spray wand on wood surfaces as it may cause damage.

House Siding (with or without detergent)

Pre-rinse cleaning surface with fresh water. If using Kärcher *Pressure Wash*, apply to surface at low pressure (for best results, limit your work area to sections of approximately 6 feet and always apply detergent from bottom to top). Allow *Pressure Wash* to remain on surface 1-3 minutes. Do not allow detergent to dry on surface, if surface appears to be drying, simply wet down surface with fresh water. If needed, use special wash brush attachment (not included) to remove stubborn dirt. Rinse at high pressure from top to bottom in an even sweeping motion keeping the spray nozzle approximately 6 inches from the cleaning surface.

Caution: Do not use rotary spray wand on siding as it may cause damage.

Cement Patios, Brick and Stone

(with or without detergent)

Pre-rinse cleaning surface with fresh water. If using Kärcher *Pressure Wash* or *Degreaser*, apply to surface at low pressure. For best results, limit your work area to smaller sections of approximately 25 square feet. Allow *Pressure Wash* or *Degreaser* to remain on surface 1-3 minutes. Do not allow detergent to dry on surface. Rinse at high pressure in a sweeping motion keeping the spray nozzle approximately 3-6 inches from the cleaning surface. Always clean from top to bottom and from left to right.

For removing extremely stubborn stains, use the rotary spray wand.

Cars, Boats & Motorcycles

(with or without detergent)

Pre-rinse vehicle with fresh water. If using Kärcher *Vehicle Wash*, apply to surface at low pressure. For best results, clean one side of vehicle at a time and always apply detergent from bottom to top, do not allow detergent to dry on surface. If needed, use special wash brush attachment (not included) to remove stubborn dirt. Rinse at high pressure in a sweeping motion keeping the spray nozzle approximately 6-8 inches from the cleaning surface (distance should increase when rinsing pin-striping or other sensitive surfaces). Always clean from top to bottom and from left to right. For best results, wipe surface dry with a chamois or soft dry cloth.

Caution: Do not use the rotary spray wand on vehicles as it may cause damage.

CLEANING TIPS – *continued*

Barbecue Grills, Outdoor Power Equipment & Gardening Tools

(with or without detergent)

Pre-rinse cleaning surface with fresh water. If using Kärcher *Pressure Wash* or *Degreaser*, apply detergent at low pressure. Allow *Pressure Wash* to remain on surface 1-3 minutes.

Do not allow detergent to dry on surface. Rinse at high pressure keeping the spray nozzle approximately 3-6 inches from the cleaning surface. For removing extremely stubborn dirt, it may be necessary to move the spray nozzle even closer to the surface for greater dirt cutting action.

Caution: Do not use rotary spray wand on cloth, plastic or other sensitive surfaces as it may cause damage.

Patio & Lawn Furniture

(with or without detergent)

Pre-rinse furniture and surrounding area with fresh water. If using *Pressure Wash*,

apply to surface at low pressure. Allow *Pressure Wash* to remain on surface 1-3 minutes. Do not allow detergent to dry on surface. If needed use special Wash Brush Attachment (not included) to remove stubborn dirt. Rinse at high pressure in a sweeping motion keeping the spray nozzle approximately 3-6 inches from the cleaning surface. For best results, clean from top to bottom and from left to right.

Caution: Do not use rotary spray wand on patio or lawn furniture as it may cause damage.

Recommendations

- Before cleaning any surface an inconspicuous area should be cleaned to test spray pattern and distance for maximum cleaning results.
- If painted surfaces are peeling or chipping, use extreme caution as pressure washer may remove the loose paint from the surface.
- When using on surfaces which might come in contact with food, flush surfaces with plenty of drinking water.

OPTIONAL CLEANING ACCESSORIES

Optional cleaning accessories are available to further enhance your cleaning capabilities: For details call 1-800-465-4980 or visit www.karcher.ca

- Rotating Wash Brush
- Wash Brush
- Underbody Wand
- Pipe Drain Cleaner
- Sandblasting Attachment
- Extension wand
- Water Siphon Kit
- 25' Extension Hose
- T-Racer

KÄRCHER 2 YEAR WARRANTY

KÄRCHER CANADA INC. warrants to the original owner that this product shall be free from defects in material and workmanship for **two years** from the date of its original purchase. If such a defect appears during the warranty period, upon presentation of proof of purchase, KÄRCHER CANADA INC. will repair or replace (at its option) your product without charge.

This warranty does not cover accidental damage, unreasonable use, normal wear and tear, loss of use or other consequential damages, nor does it cover repairs made or attempted by unauthorized persons.

Trigger gun, hose, spray wands and other accessories are warranted for **3 months**.

Please note that no returns will be accepted without prior authorization from our customer service department.

It is the owner's responsibility to file claims for damage caused by public transportation carriers directly with the carrier concerned.

TROUBLESHOOTING

Disconnect the machine from the power source before making any repair.

Symptom	Cause	Solution
Motor will not start.	On/Off switch is in the "OFF" (O) position.	Turn switch to the "ON" (I) position
	Power cord is not plugged in.	Plug in power cord.
	Extension cord is too long. Extension cord is not proper gauge. Extension cord is damaged.	Replace extension cord with either a 25 ft. 12/3 gauge cord or a 50 ft. 10/3 gauge cord.
	Electrical outlet does not supply adequate power.	Try a different outlet.
Unit does not reach high pressure.	Diameter of garden hose is too small.	Replace with a 1/2 inch or 5/8 inch garden hose.
	Water supply is restricted.	Check garden hose for kinks, leaks and blockage.
	Not enough inlet water supply.	Open water source full force.
	Water inlet filter is clogged.	Remove filter and rinse out in warm water.
	Spray wand is on low pressure position.	Turn spray wand to high pressure position.
Output pressure varies high and low.	Not enough inlet water supply.	Turn water on full force. Check garden hose for kinks, leaks or blockage.
	Pump is sucking air.	Check that hoses and fittings are air tight. Turn off machine and purge pump by squeezing trigger gun until a steady flow of water emerges through the nozzle.
	Water inlet filter is clogged.	Remove filter and rinse out in warm water.
	Discharge nozzle is obstructed.	Blow out or remove debris with a fine needle.
	Calcified gun, hose or spray wand.	Run distilled vinegar through detergent tank.

TROUBLESHOOTING – *continued*

Symptom	Cause	Solution
No detergent.	Detergent is too thick.	Dilute detergent.
	Spray wand is in high pressure position.	Turn spray wand tip to low pressure position.
	Discharge nozzle is obstructed.	Blow out or remove debris with a fine needle.
Spray wand leaks.	Spray wand not properly attached.	Insert the spray wand into the trigger gun. Carefully press in against the spring tension and twist into the locked position.
	Broken o-ring or plastic insert.	Call Customer Service.
Pump is noisy.	Pump is sucking air.	Check that hoses and fittings are air tight. Turn off machine and purge pump by squeezing trigger gun until a steady flow of water emerges through the nozzle.
Water leaks from pump (up to 10 drops per minute is permissible).	Loose fittings.	Check that all fittings are tight.
	Water seals are damaged or worn.	Call Customer Service.
Oil Drips.	Oil seals are damaged or worn.	Call Customer Service.