

**KÄRCHER**

205 M plus

275 M plus



**KÄRCHER**

---

# Safety instruction for high-pressure cleaners

---

## Before start-up please read these instructions !

Before using the machine please read the operating instructions for your unit and comply in particular with these safety instructions.

The warning and information signs attached to the unit provide important information for safe operation.

Apart from the information in the operating instructions comply with the general safety regulations and regulations for the prevention of accidents.

### Power supply

The voltage indicated on the rating plate must correspond to the voltage of the power source.

We recommend that this equipment is only connected into a socket which is protected by a circuit-breaker that would be actuated by a 30 mA residual current.

Only use or replace power supply cables for this unit which correspond to the types indicated by the manufacturer. See the operating instructions for the order no. and types.

If the plug is damaged, pay attention to the following: Plugs and sockets confirming to BS 4243 or BS 196 should be used wherever practicable. Domestic pattern plugs to BS 546 should not be used. The wiring of the plug should leave more slack in the earth continuity conductor than in the other cores, so that it is not the first core to be pulled out of its terminal should the cord grip fail. Plugs which have good grips capable of maintaining a firm hold on the cable sheath should be selected. In general, additional means should be provided to relieve stress on cable terminations in the plug. For example, additional cable clamps should be fitted or a substantial chain could be used to tether the machine to a fixed point. Plugs and sockets situated near the work site or outdoors should be to class IP 55 of BS 5490 to provide adequate protection against ingress of water, etc. and cable entries require effective sealing. Rubber shrouds should be provided over cable glands. Drip-proof (class IP X2 of BS 5490) plugs and sockets to BS 4343 are suitable for use indoors where the plug is away from the water spray area where the appliance is in use.

Never touch the mains plug with wet hands.

Do not run over, crush or pull the power supply cable or extension lead, otherwise it may be damaged. Protect the cable from heat, oil and sharp edges.

The extension lead must have a cross section in accordance with the operating instructions and be protected against splashed water. The connection must not be in water.

When replacing couplings on the power supply cable or extension lead the spray water guard and mechanical stability must remain in tact.

### Water supply

Comply with the regulations of your water supply company.

All connecting hoses must have properly sealed joints.

The high-pressure hose must not be damaged (danger of bursting). A damaged high-pressure hose must be replaced immediately. Only use hoses and connections recommended by the manufacturer.

### Application

Before use, check that the unit and operating equipment are in perfect condition and are safe to operate. Do not use the unit if it is not in perfect condition.

Never draw in solvent-containing liquids, undiluted acids or solvents! This includes petrol, paint thinners and heating oil. The sprayed vapour is highly flammable, explosive and toxic; also acetone, undiluted acids and solvents as these corrode the materials used on the unit.

The appropriate safety regulations must be observed when using the unit in dangerous areas (e.g. petrol stations). It is forbidden to operate the unit in potentially explosive locations.

The unit must be placed on a solid base.

Only use detergents recommended by the manufacturer and comply with the application, disposal and warning instructions of the detergent manufacturers.

All current-conducting components in the working area must be protected against splashed water.

---

# Safety instruction for high-pressure cleaners

---

## Before start-up please read these instructions !

The gun trigger must not be jammed in position during operation.

Suitable protective clothing must be worn if necessary to protect against splashing from some parts.

Never direct the water jet at people, animals, the unit or electric components.

Vehicle tyres/tyre valves may only be cleaned from a minimum distance of 30 cm, otherwise the vehicle tyre/tyre valve could be damaged by the high-pressure jet. The first indication of this is a discoloration of the tyre. Damaged vehicle tyres/tyre valves can be deadly dangerous.

Materials containing asbestos and other materials which contain substances which are hazardous to your health must not be sprayed.

Only use detergents which have been approved by the manufacturer of the unit.

Detergents must not be used undiluted. The products are safe to use as they contain no acids, alkalis or substances which are detrimental to the environment. We recommend that the detergents are kept out of the reach of children. If detergent comes into contact with the eyes wash immediately with plenty of water and if swallowed contact a doctor immediately.

Do not lift up the bonnet while the motor is running.

### Operation

The operator must use the unit in accordance with the regulations. He/she must take local conditions into account and be aware of other people, especially children, when operating the unit.

The unit may only be used by authorized persons who have received training or have demonstrated

their ability to operate the unit. The unit must not be operated by children or juveniles (danger of accidents due to incorrect use of the unit).

The unit must never be left unsupervised while the motor is running.

The water jet from the high-pressure nozzle produces a recoil on the gun. You should therefore hold the gun and spray lance firmly.

### Transport

Switch off the motor and secure the unit before transporting.

### Maintenance

Switch off the unit prior to all cleaning and maintenance work and before replacing components. Pull out the mains plug if the unit is mains-operated.

Repairs may only be carried out by authorized customer service centres or by specialists in this field who are familiar with all the relevant safety regulations.

### Accessories and spare parts

Only use accessories and spare parts which have been approved by the manufacturer. Original accessories and spare parts guarantee that the unit can be operated safely and without any breakdowns.

---

## Kärcher 205 M plus / Kärcher 275 M plus

---

### **Purpose**

- Use the appliance to clean machines, vehicles, buildings, tools etc.
- Clean facades, terrasses, garden equipment etc. without detergent only with the high-pressure spray.
- Cleaning with the use of a high-pressure cleaner brings an 85% reduction in the consumption of fresh water.
- Cleaning tasks which produce waste water mixed with oil – e.g. when washing engines or the undersides of vehicles – should only be carried out at a specific washing point that is equipped with an oil separator.

# Kärcher 205 M plus / Kärcher 275 M plus

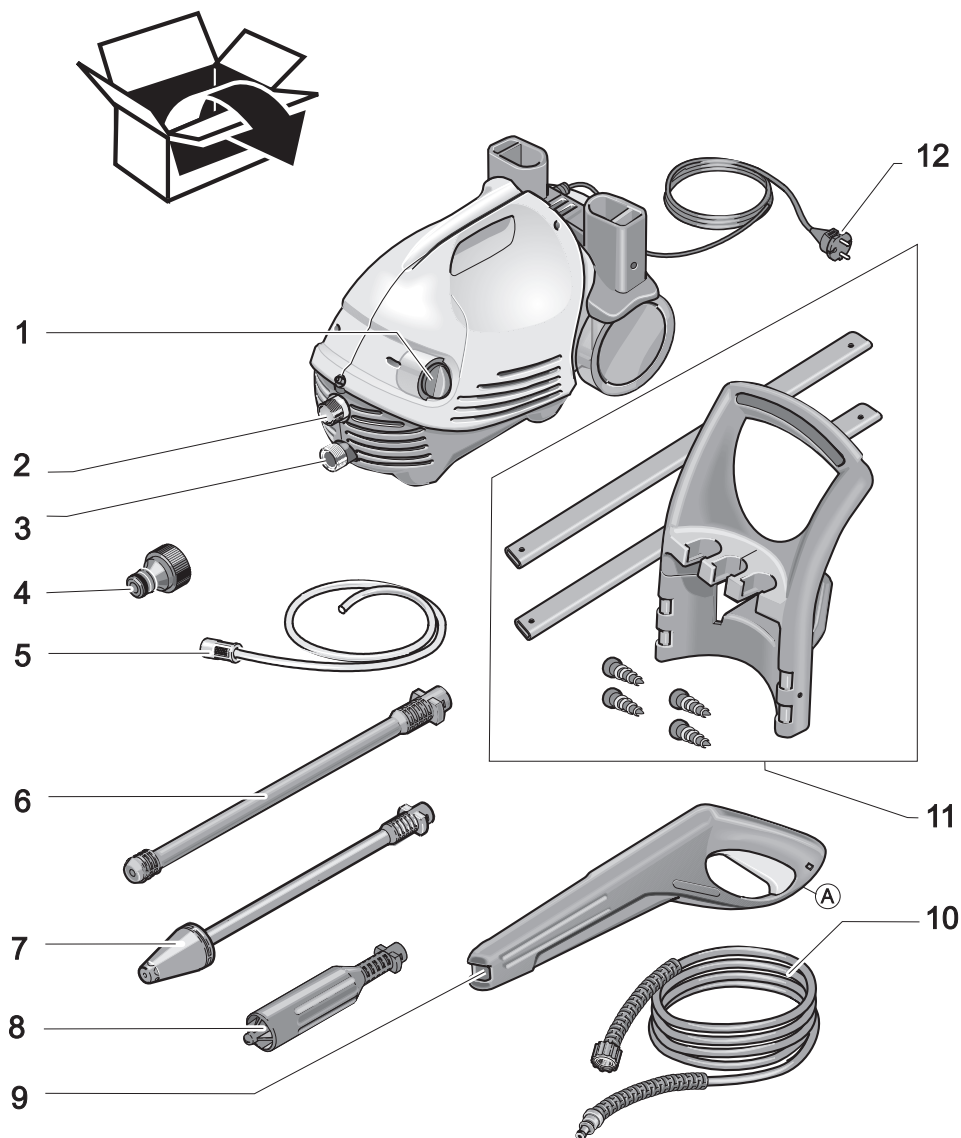

1 Appliance switch (ON/OFF)

2 High-pressure outlet

3 Water connection with filter

4 Coupling

5 Detergent suction hose

6 Spray lance with high-pressure nozzle

7 Spray lance with dirt blaster

8 Low pressure spray lance

9 Spray gun with safety ratchet (A)

10 High-pressure hose

11 Transport handle

12 Connection lead

# Starting

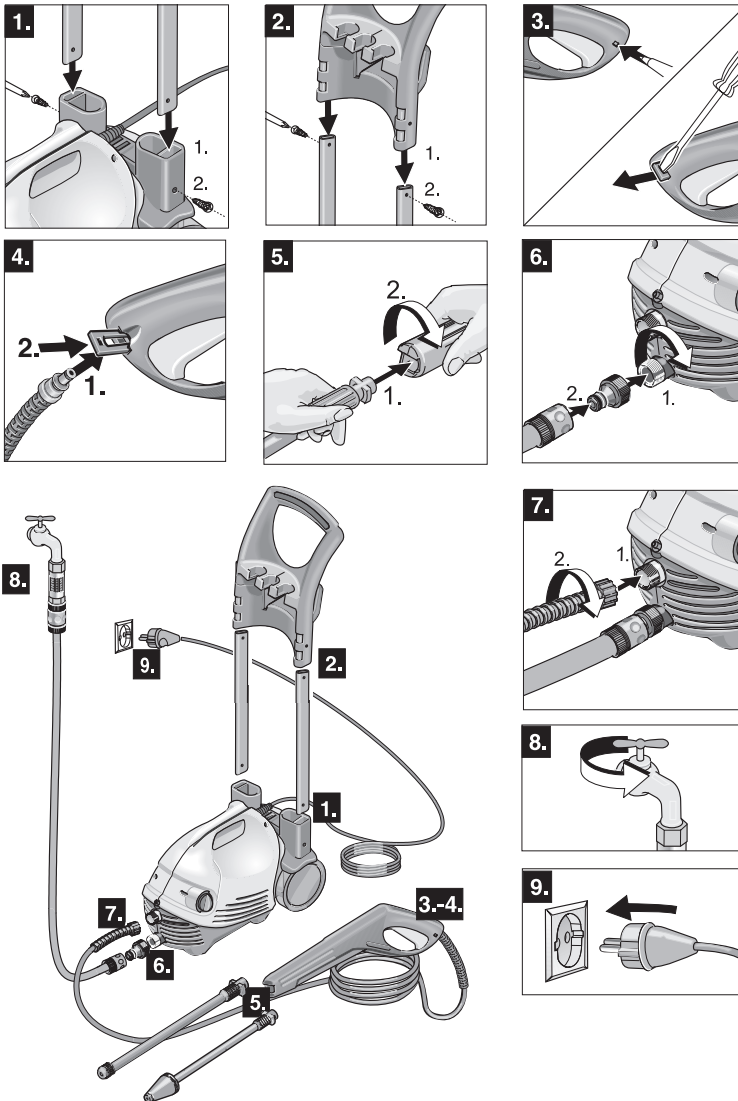

- Do not simply discard the packing materials with the house-hold waste. Take the packing materials to the appropriate collection areas for recycling.
- Dirt in the feed water could lead to the appliance being damaged. To avoid this risk, we recommend fitting a filter with 3/4" connection .

- If you are using an extension cable, it should always be completely unwound from the cable drum and have a sufficient cross-sectional area.

Cable length max.	10 m	30 m
Cross-sectional area	3 x 1,5 mm <sup>2</sup>	3 x 2,5 mm <sup>2</sup>

## Operation with high pressure

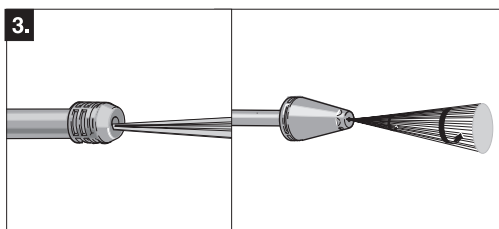
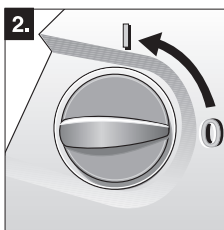
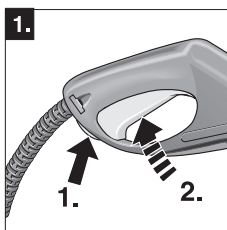

- The appliance is equipped with a pressure-operated switch. The motor starts only if the lever of the gun is pulled.
- The safety ratchet does not lock the trigger of the gun during operation but only prevents it from opening unintentionally.
- To avoid any risk of damage to the surface being cleaned, when the machine is in use, it is recommended that a minimum distance of 300 mm be kept between the surface and the spray nozzle. The machine should not be used to clean surfaces that are already damaged or worn e.g. flaking or scratched paintwork, crumbling brickwork or concrete etc.

# Operation with Detergent

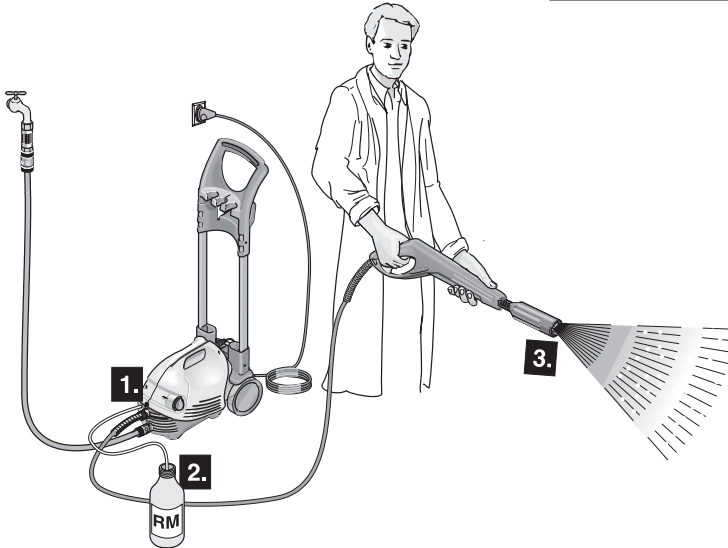
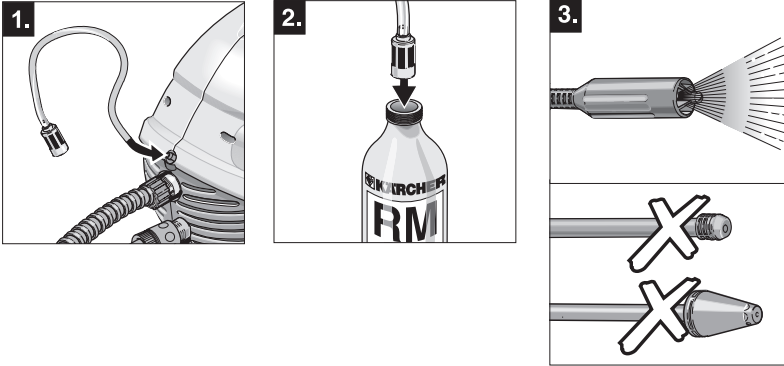

• We recommend that you use detergent sparingly for the sake of the environment. Observe the recommended dosage on the detergent label.

• By offering you an individualised range of cleaning and preserving agents, Kärcher guarantees trouble-free operation of the unit. Request more information or ask for our catalogue and/or individual information brochures on specific detergents.

- *Profi RM 555 ASF, Universal cleaner*

This cleaning agent may be used undiluted.

- *Profi RM 555 ULTRA, Universal cleaner*

- *Profi RM 555 ULTRA, Automotive cleaner*

- *Profi RM 565 ULTRA, House and garden cleaner*

- *Profi RM 575 ULTRA, Boat cleaner*

Before using, these cleaning agents must be diluted with 9 parts of water (1:9).

We recommend the following cleaning methods:

## Step 1: Loosening dirt

Spray on detergent sparingly and allow to react for a short time.

## Step 2: Removing dirt

Spray off the loosened dirt with the high-pressure spray.



## Switching OFF

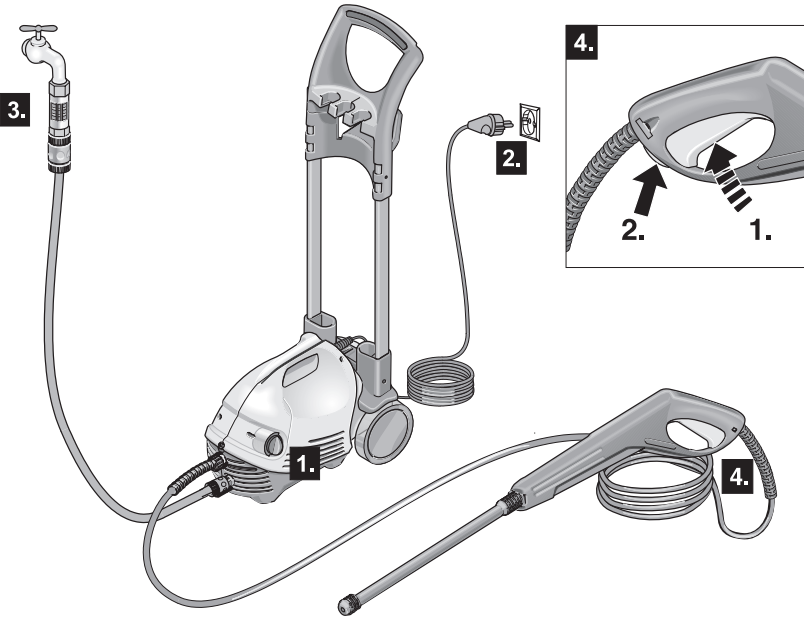
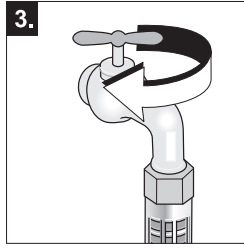
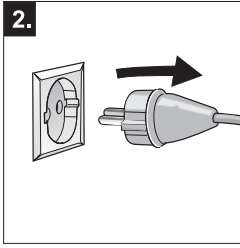
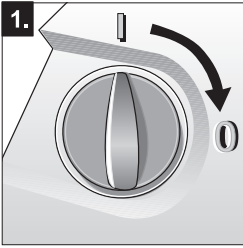

- Pull the trigger until there is no more pressure in the appliance, and secure the trigger with the safety ratchet against unintentional opening.

## Care and maintenance

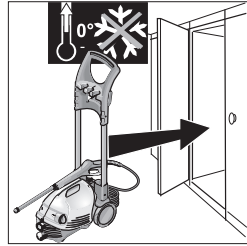
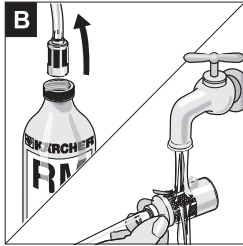
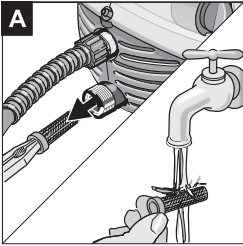

- The appliance should be rinsed clean after detergent has been used. To do this, suspend the detergent suction hose in a container of clean water, and run the pump for approx. 1 minute.
- Frost will destroy an appliance which has not been completely emptied of water. Ideally, the appliance should be stored in a frost-free room.

---

# Troubleshooting

---

**! Note:** *Disconnect the appliance from the power mains before all repair work.*

## **Appliance does not Work**

- Check whether the voltage shown on the rating plate corresponds to that of the power source.
- Check the connector cable for damage.

## **Appliance does not reach Operational Pressure**

- Vent the appliance: Allow the pump to operate without the high-pressure hose until water appears at the high-pressure outlet without any more bubbles. Then reattach the high-pressure hose.
- Clean the strainer in the water connection.
- Check the inlet water flow rate.
- Check all inlet pipes to the pump for leaks or block-age.

## **Strong Pressure Fluctuations**

- Clean the high-pressure nozzle.  
Remove dirt from the nozzle hole with a needle and then rinse out with water from the front.

## **Pump Leaks**

- 10 drops per minute are permissible. In the case of more serious leakage, you should contact the authorized customer service.

## **No Detergent Suction**

- Set the double nozzle to low pressure.
- Clean the detergent suction hose with filter, and check for leaks.

---

# General Information

---

## **Safety Equipment**

When the spray gun is closed, the overflow valve switches off the appliance via a pressure-operated switch. The overflow valve is also a safety device against exceeding the maximum allowable working pressure.

## **Spare Parts**

A selection of the most common spare parts numbers is listed at the end of these operating instructions.

## **Guarantee**

The terms and conditions of guarantee issued by a national Kärcher Company are valid in the relevant country.

If the appliance malfunctions in any way, the fault will be rectified free of charge within the period of the guarantee provided the malfunction is due to faulty material or a manufacturing error and all the terms and conditions are met.

# Technical Data

## Power connection

Voltage (1~50/60 Hz) .....	230-240	V
Connected load .....	1,6	kW
Mains fuse (slow) .....	13	A
Protection class .....	2	

## Water connection

Supply temperature (max.) .....	40	°C
Supply rate (min.) .....	600	l/h
Supply pressure .....	2-12	bar
Supply hose – length (min.) .....	7,5	m
– diameter (min.) .....	1/2	in

## Performance data

Max. permissible pump pressure .....	110	bar
Rated pressure .....	100	bar
EWE (equivalent washing efficiency with dirt blaster) .....	150	
Flow rate .....	360	l/h
Detergent intake .....	25	l/h
Recoil force of spray gun at operating pressure (max.) .....	13	N
Sound pressure level (DIN 45635) .....	78	dB(A)

## Dimensions

Length .....	410	mm
Width .....	220	mm
Height .....	900	mm
Weight without accessories .....	6	kg

## Circuit Diagram

- M1 Motor
- Q1 Appliance switch
- S1 Pressure-operated switch
- Z 1 Suppressor

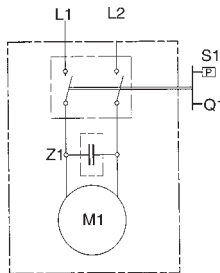

# EU Declaration of Conformity

We hereby declare that the equipment described below conforms to the relevant fundamental safety and health requirements of the appropriate EU Directives, both in its basic design and construction as well as in the version marketed by us. This declaration will cease to be valid if any modifications are made to the machine without our express approval.

Product: **High-pressure cleaner**  
Model: **1.072-xxx, 1.223-xxx**

## Relevant EU Directives:

EU Low-Voltage Equipment Directive (73/23/EEC) amended by 93/68/EEC.  
EU Machinery Directive (98/37/EEC)  
EU Directive on Electromagnetic Compatibility (89/336/EEC)  
amended by 91/263/EEC, 92/31/EEC, 93/68/EEC.

## Harmonised standards applied:

DIN EN 55014-1:1993      DIN EN 60335-1      DIN EN 61000-3-2:1995  
DIN EN 55014-2:1997      DIN EN 60335-2-79      DIN EN 61000-3-3:1995

Appropriate internal measures have been taken to ensure that series-production units conform at all times to the requirements of current EU Directives and relevant standards. The signatories are empowered to represent and act on behalf of the company management.

Alfred Kärcher GmbH & Co.  
Cleaning Systems  
Alfred-Kärcher-Str. 28-40  
P.O. Box 160  
D-71349 Winnenden  
Tel.: ++ 49 71 95 14-0  
Fax: ++ 49 71 95 22 12

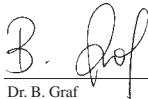
  
Dr. B. Graf

  
S. Reiser

  
H. Jenner

Alfred Kärcher Kommanditgesellschaft. Sitz Winnenden. Registergericht: Waiblingen, HRA 169.  
Persönlich haftende Gesellschafterin: Kärcher Reinigungstechnik GmbH, Sitz Winnenden, 2404 Registergericht Waiblingen, HRB  
Geschäftsführer: Dr. Bernhard Graf, Roland Kamm, Herbert Konhäusner, stellv.: Hartmut Jenner, Thomas Schöbinger

02-00

---

## AFTER SALES SERVICE

---

If your machine does not appear to be working correctly please refer to **Troubleshooting**. If this fails to resolve the problem, or in the event of a breakdown please ring the **Karcher Customer Helpline on 01295 752200** during office hours

Please have ready the model number and date of purchase of your machine along with clear and concise details of the fault.

# Spare Parts

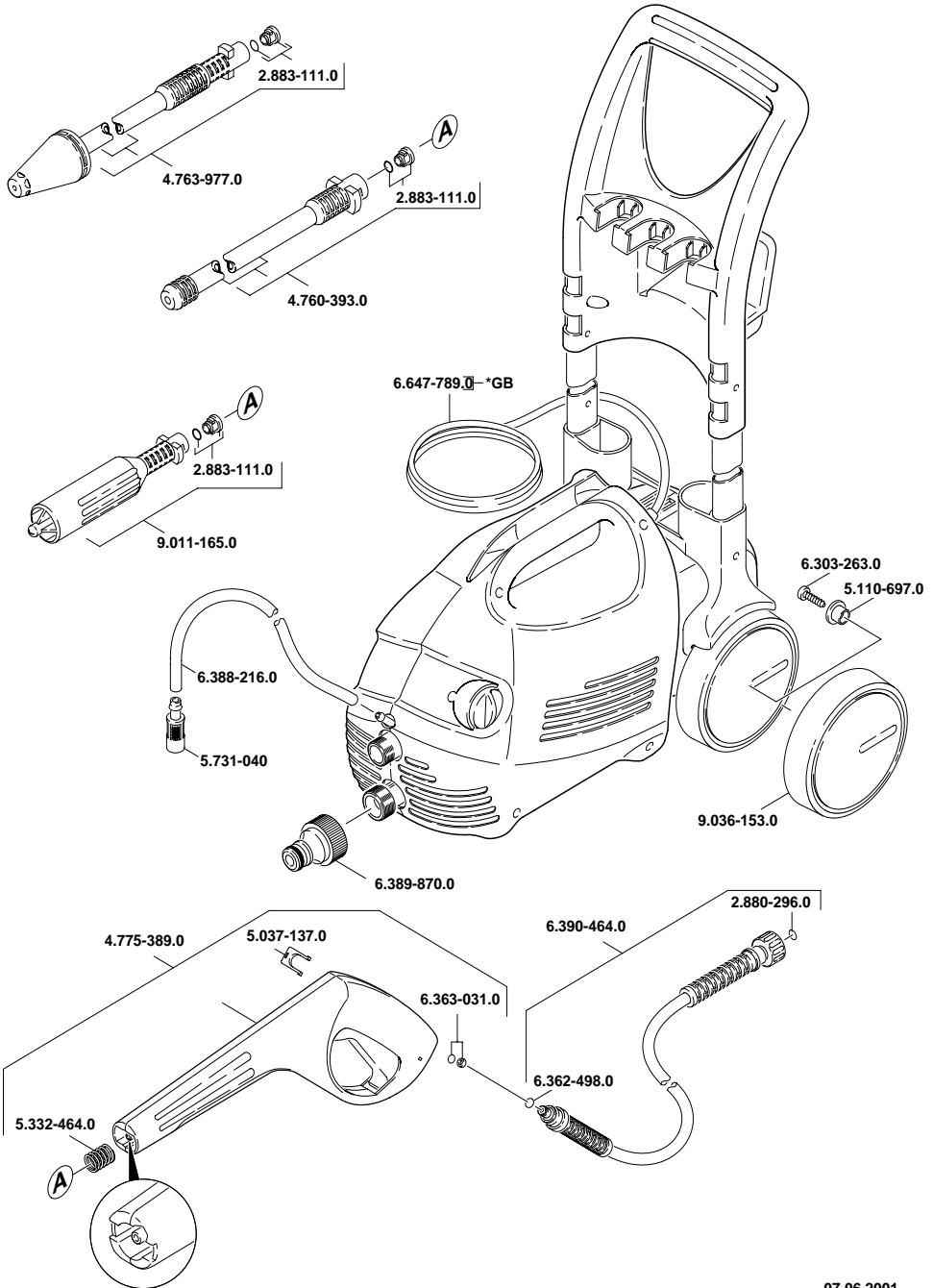

# **m** IMPORTANT SAFETY NOTES

## **ELECTRICAL CONNECTION AND SUPPLY**

### **WARNING - THIS APPLIANCE MUST BE EARTHED**

*The supply voltage must be the same as that shown on the rating plate.*

**Important:** If a new plug is to be fitted

- the wires in the mains lead are coloured in accordance with the following code:

Green and yellow	- Earth
Blue	- Neutral
Brown	- Live
- as the colours of the wires in the mains lead of this appliance may not correspond with the markings identifying the terminals in your plug, proceed as follows:
- the wire which is marked with the letter “E” or by the earth symbol  or coloured green and yellow
- the wire which is coloured blue must be connected to the terminal which is marked with the letter “N” or coloured black
- the wire which is coloured brown must be connected to the terminal which is marked with the letter “L” or coloured red
- each wire must be properly connected to the appropriate terminal pin of a suitable plug and the outer sheath of the mains lead securely retained by the cable clamp arrangement of the plug
- If a 13 Amp BS 1363 plug is used it should be fitted with a 13 Amp fuse

*If any doubt, contact your nearest Karcher Authorised Agent or Qualified Electrician*