

K 2.400

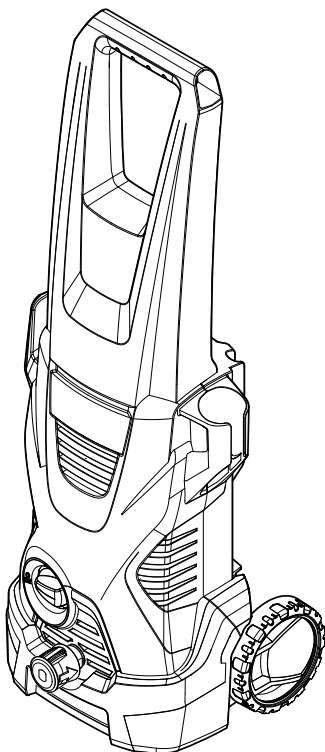

English

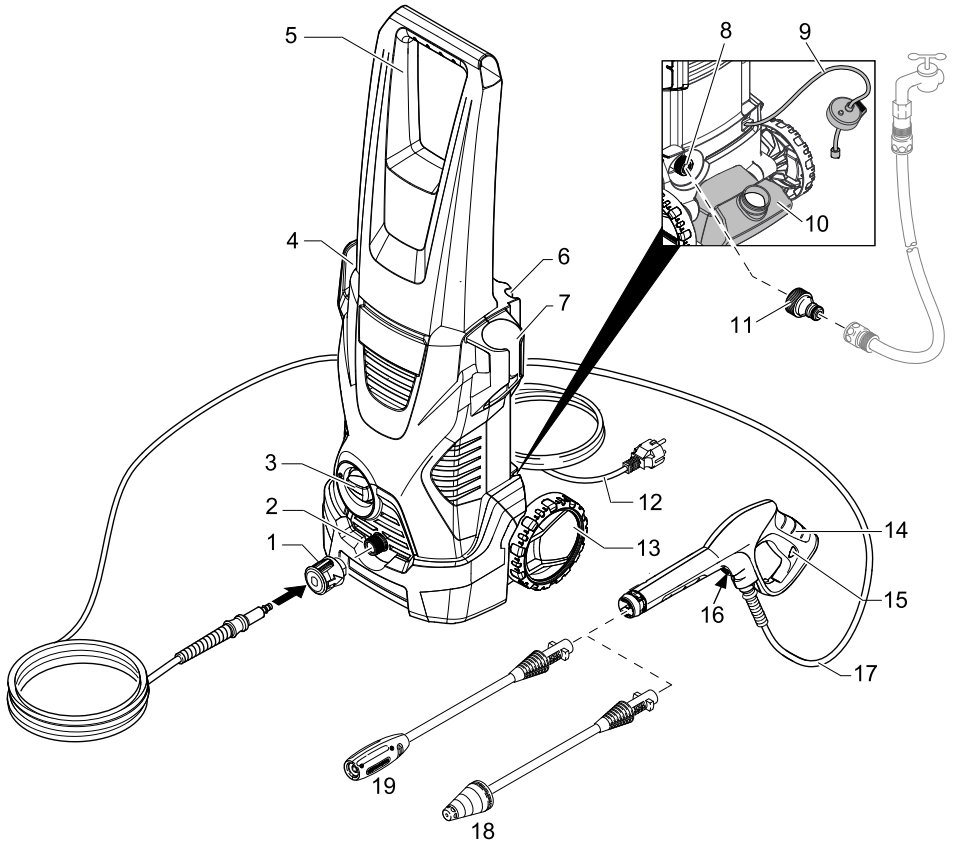



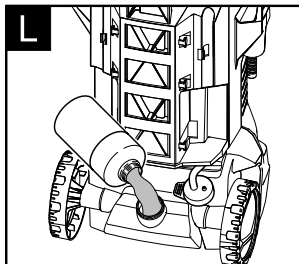
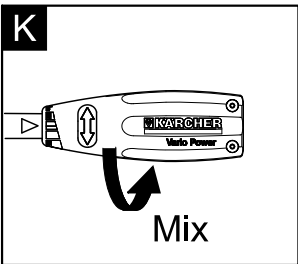
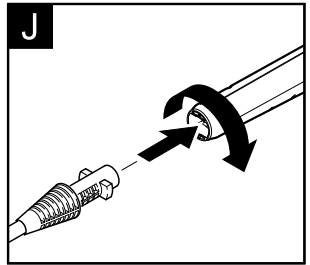
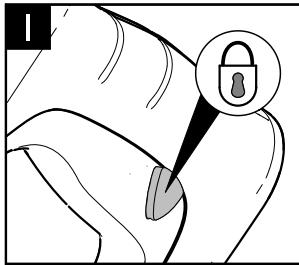
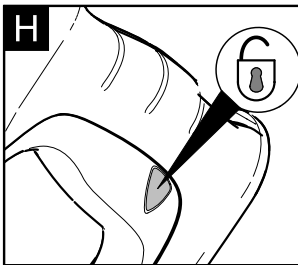
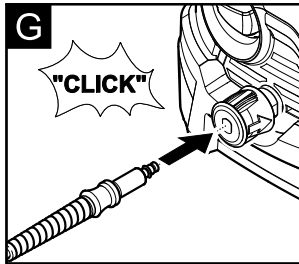
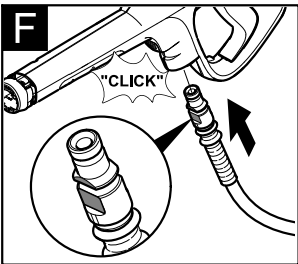
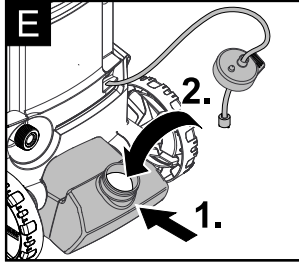
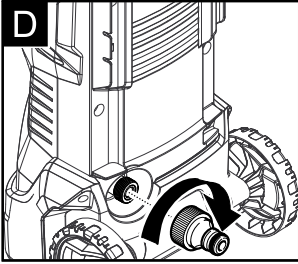
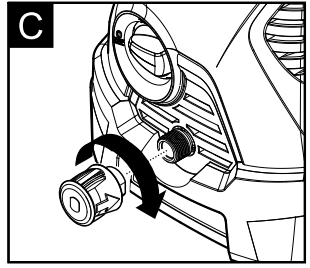
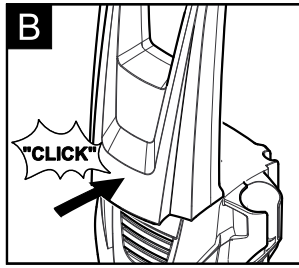
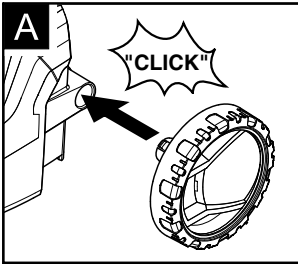

Contents

General information	4
Safety	5
Description of the Appliance	8
Before Startup	8
Start up	9
Operation	9
Transport	11
Storage	11
Maintenance and care	11
Troubleshooting	12
Accessories and Spare Parts	13
Warranty	13
Technical specifications	13

General information

Dear Customer.



Please read and comply with these original instructions prior to the initial operation of your appliance and store them for later use or subsequent owners.

Scope of delivery

The scope of delivery of your appliance is illustrated on the packaging. Check the contents of the appliance for completeness when unpacking.

In the event of missing accessories or any transport damage, please contact your dealer.

Proper use

This high pressure cleaner is designed for domestic use only.

- for cleaning machines, vehicles, buildings, tools, facades, terraces, gardening tools, etc. by means of a high-pressure water jet (if necessary, with additional cleaning agents).

- with accessories, replacement parts and cleaning agents approved by KÄRCHER. Please observe the information accompanying the cleaning agents.

Environmental protection



The packaging material can be recycled. Please do not place the packaging into the ordinary refuse for disposal, but arrange for the proper recycling.



Old appliances contain valuable materials that can be recycled.

- Please arrange for the proper recycling of old appliances. Please dispose your old appliances using appropriate collection systems.



Work with detergents must only be performed on liquid-tight work surfaces with connections to the wastewater runoff. Do not let release detergent into waters or earth.



Cleaning operations which produce oily waste water, e.g. engine washes, underbody washes, may only be carried out using washing stations equipped with an oil separator.

Notes about the ingredients (REACH)

You will find current information about the ingredients at:

www.kaercher.com/REACH

Safety

Meaning of the notes

△ Danger

Pointer to immediate danger, which leads to severe injuries or death.

△ Warning

Pointer to a possibly dangerous situation, which can lead to severe injuries or death.

△ Caution

Pointer to a possibly dangerous situation, which can lead to minor injuries.

Caution

Pointer to a possibly dangerous situation, which can lead to property damage.

Symbols on the machine



The high pressure jet may not be directed at persons, animals, live electrical equipment or at the appliance itself.

Protect the appliance against frost.

Electric components

△ Danger

- Never touch the mains plug and the socket with wet hands.
- Check the power cord with mains plug for damage prior to every use. Immediately have damaged power cord replaced by an authorised customer service / electrician. Do not operate an appliance if the power cord is damaged.

- All current-conducting parts in the working area must be protected against jet water.
- The mains plug and the coupling of an extension cable must be watertight and must never lie in water. Moreover, the coupling may never lie on the ground. The use of cable reels that ensure that the sockets are at least 60 mm above the ground is recommended.
- Make sure that the power cord or extension cable is not damaged by running over, pinching, dragging or the like. Protect the power cords from heat, oil, and sharp edges.
- △ **Warning**
 - The appliance may only be connected to alternating current. The voltage must correspond with the type plate of the appliance.
 - The appliance may only be connected to an electric supply that has been installed by an electrician in accordance with IEC 60364.
 - Unsuitable electrical extension cables can be hazardous. Only use electrical extension cables outdoors which have been approved and labelled for this purpose and have an adequate cable cross-section: 1 - 10 m: 1.5 mm²; 10 - 30 m: 2.5 mm².
 - Always fully unreel the extension cable from the cable drum.

- *For safety reasons, we recommend that you operate the appliance only via a residual current device (max. 30 mA).*

Safe handling

⚠ Danger

- *Check important components, such as high-pressure hose, hand spray gun and safety installations, for damage prior to every operation. Immediately replace damaged components. Do not operate appliance with damaged components.*
- *The high-pressure jet must not be directed at other persons or the user him-/herself to clean clothing or footwear.*
- *Never use the appliance to clean objects containing hazardous substances (e.g. asbestos).*
- *Vehicle tyres/tyre valves are susceptible to damage from the high-pressure jet and may burst. The first indication for this is a discolouration of the tyre. Damaged vehicle tyres/tyre valves are perilous. Keep a minimum jet distance of 30 cm during cleaning!*
- *Keep packaging films away from children, there is a risk of suffocation!*

⚠ Warning

- *The appliance must not be operated by children or persons who have not been instructed accordingly.*

- *This appliance is not intended for use by persons with limited physical, sensory or mental capacities or lacking experience and/or skills, unless such persons are accompanied and supervised by a person in charge of their safety or they have received precise instructions on the use of this appliance and have understood the resulting risks.*
- *Children must not play with this appliance.*
- *Supervise children to prevent them from playing with the appliance.*
- *The user must use the appliance as intended. The person must consider the local conditions and must pay attention to other persons in the vicinity when working with the appliance.*
- *High-pressure hoses, fixtures and couplings are important for the safety of the appliance. Only use high-pressure hoses, fixtures and couplings recommended by the manufacturer.*
- *Do not use the appliance when there are other persons around unless they are also wearing protective clothing.*
- *This appliance was designed to be used with detergents which are supplied or recommended by the manufacturer. The use of other detergents or chemicals may compro-*

mise the safety of the appliance.

⚠ Caution

- *In case of extended breaks, switch the appliance off at the main switch / appliance switch or pull the mains plug.*
- *Keep a distance of at least 30 cm when using the jet for cleaning painted surfaces to avoid damage.*
- *Never leave the appliance unattended as long as it is in operation.*
- *Do not operate the appliance at temperatures below 0 °C.*

Other risks

⚠ Danger

- *Do not spray flammable liquids.*
- *Never draw in fluids containing solvents or undiluted acids and solvents! This includes petrol, paint thinner and heating oil. The spray mist is highly inflammable, explosive and poisonous. Do not use acetone, undiluted acids and solvents, as they corrode the materials used on the appliance.*
- *The appliance may not be operated in explosive atmospheres.*
- *If the appliance is used in hazardous areas (e.g. filling stations) the corresponding safety regulations must be observed.*

Personal protective equipment

Wear protective clothing and safety goggles to protect against splash back containing water or dirt.

Stability

⚠ Caution

Create stability for the appliance prior to any work on or with the appliance to prevent accidents or damage.

- ➔ *The stability of the appliance is warranted when it is placed onto an even surface.*

Safety Devices

⚠ Caution

Safety installations serve the protection of the user and may not be modified or bypassed.

Appliance switch

The appliance switch prevents unintentional operation of the appliance.

Lock trigger gun

This lock locks the lever of the trigger gun and prevents the inadvertent start of the appliance.

Overflow valve with pressure switch

The overflow valve prevents the permissible working pressure from being exceeded.

If the lever on the trigger gun is released the pressure switch turns off the pump, the high pressure jet is stopped. If the lever is pulled the pump is turned on again.

Description of the Appliance

Illustrations on Page 2

- 1 Quick coupling for high pressure hose
- 2 High pressure connection
- 3 Appliance switch "0/OFF"/ „I/ON“
- 4 Storage hook for high pressure hose and mains connection cable
- 5 Transport handle
- 6 Storage for spray lances
- 7 Storage for trigger gun
- 8 Water connection with integrated sieve
- 9 Detergent suction hose (with sieve)
- 10 Detergent Tank
- 11 Coupling element for water connection
- 12 Mains cable with mains plug
- 13 Bearing wheel
- 14 Trigger gun
- 15 Lock trigger gun
- 16 Key to detach the high pressure hose from the trigger gun
- 17 High pressure hose
- 18 Spray lance with Dirtblaster For strong contaminations
- 19 Spray lance with pressure regulation (Vario Power)
Carrying out the most common cleaning tasks. The work pressure can be stagelessly regulated between "Min" and "Max". You can add detergent when "Mix" is selected. In order to adjust the working pressure, release the lever of the hand spray gun and turn the spray lance to the desired position.

*** Not included in the scope of delivery.**

- 20 Water supply hose
Use a fabric reinforced water hose with a commercially available coupling. Minimum diameter 13 mm (1/2 inch); minimum length 7.5 m.

Before Startup

Attaching the Accessories

Mount loose parts delivered with appliance prior to start-up.

Illustrations on Page 3

Illustration **A**

→ Insert the transport wheels and lock them.

Illustration **B**

→ Attach the transport handle.

Illustration **C**

→ Fasten the quick coupling for the high pressure hose to the high pressure connection.

Illustration **D**

→ Screw the coupling element to the water connection on the appliance.

Illustration **E**

→ Pull the suction hose for detergent through the cover of the detergent tank until the filter contacts the bottom of the tank.

→ Close the detergent tank with the lid.

→ Lock the detergent tank in place on the appliance.

Illustration **F**

→ Push the high pressure hose into the trigger gun until it locks audibly.

Note: Make sure the connection nipple is aligned correctly.

→ Check the secure connection by pulling on the high pressure hose.

Water supply

For connection values, see type plate/technical data.

Observe regulations of water supplier.

⚠ Warning

According to applicable regulations, the appliance must never be used on the drinking water net without a system separator. A

suitable system separator by KÄRCHER or alternatively a system separator according to EN 12729 type BA must be used.

Water that has flown through a system separator is no longer classified as drinking water.

Caution

Always connect the system separator to the water supply, never directly to the appliance!

Caution

Impurities in the water can damage the high-pressure pump and the accessories. For protection, the use of the KÄRCHER water filter (optional accessory, order no. 4.730-059) is recommended.

Start up

Caution

Dry running of more than 2 minutes leads to damage of the high-pressure pump. If the appliance does not build up pressure within 2 minutes, switch the appliance off and proceed in accordance with the instructions in Chapter "Troubleshooting".

Illustration 

- Push the high pressure hose into the quick coupling until it locks audibly.
- Attach the water supply hose to the coupling on the water connection.
Note: The supply hose is not included.
- Connect the water supply hose to the water supply.
- Completely open the water tap.
- Insert the mains plug into the socket.
- Turn on the appliance "I/ON".

Illustration 

- Unlock the lever on the trigger gun.
- Pull on the lever of the trigger gun; the device will switch on.
Switch the appliance on for a (max. of 2 minutes) and wait until the water exits at the hand spray gun without bubbles.
- Release the lever on the trigger gun.

Illustration 

- Lock the lever on the trigger gun.

Operation

△ Danger

The water jet that is emitted from the high-pressure nozzle results in a repulsion power acting on the hand spray gun. Make sure that you have a firm footing and are also holding the hand spray gun and spray lance firmly.

△ Danger

High-pressure jets can be dangerous if improperly used. The jet may not be directed at persons, animals, live electrical equipment or at the appliance itself.

Caution

Car tyres, paint or sensitive surfaces such as wood should not be cleaned with the dirt blaster, as there is a risk of damage.

Illustration 

- Push the spray lance into the trigger gun and fasten it by turning it through 90°.

Illustration 

- Unlock the lever on the trigger gun.
- Pull on the lever of the trigger gun; the device will switch on.

Note: Release the lever of the trigger gun; the device will switch off again. High pressure remains in the system.

Working with detergent

⚠ Danger

The use of wrong detergents or chemicals can compromise the safety of the appliance.

Please use exclusively KÄRCHER detergents and care products to carry out the respective cleaning task, as these were specifically developed for your appliance. The use of other detergents and care products may lead to premature wear and can invalidate your warranty claims. Please obtain information at your local dealer or request information directly from KÄRCHER.

⚠ Danger

The improper use of detergents can cause severe injuries or intoxication.

When using detergents, the material data safety sheet issued by the detergent manufacturer must be adhered to, especially the instructions regarding personal protective equipment.

Illustration 

→ Fill the detergent solution in the detergent tank (observe dosage instructions on the packaging of the detergent).

Illustration 

→ Use spray lance with pressure regulation (Vario Power).

→ Turn the spray lance to "Mix" position.

Note: This will mix the detergent with the water stream.

Recommended cleaning method

- Spray the detergent sparingly on the dry surface and allow it to react, but not to dry.
- Spray off loosened dirt with the high pressure jet.

Interrupting operation

- Release the lever on the trigger gun.
- Lock the lever on the trigger gun.
- Insert the trigger gun in its holder.
- During longer breaks (more than 5 minutes), also turn the appliance off using the "0/OFF" switch.

Finish operation

⚠ Caution

Only separate the high-pressure hose from the hand spray gun or the appliance when there is no pressure in the system.

- After operation with detergent: Run the machine for approximately 1 minute for a clear rinse.
- Release the lever on the trigger gun.
- Turn off the appliance "0/OFF".
- Turn off tap.
- Press the lever on the trigger gun to release any remaining pressure in the system.
- Lock the lever on the trigger gun.
- Detach the appliance from the water supply.
- Disconnect the mains plug from the socket.

Transport

⚠ Caution

In order to prevent accidents or injuries, mind the weight of the appliance during transport (see technical data).

When transporting by hand

- Pull the appliance by its transport handle.

When transporting in vehicles

- Empty detergent tank.
- Secure the appliance against shifting and tipping over.

Storage

⚠ Caution

In order to prevent accidents or injuries, mind the weight of the appliance when choosing the storage location (see technical data).

Storing the Appliance

Prior to extended storage periods, as during the winter, also observe the instructions in the Care section.

- Park the machine on an even surface.
- Press the disconnect on the trigger gun and remove the high pressure hose from the trigger gun.
- Push the casing of the quick coupling for the high pressure hose toward the rear and disconnect the high pressure hose from the appliance.
- Insert the trigger gun in its holder.
- Engage the spray lance in its compartment.
- Stow away the mains cable, the high-pressure hose and accessory on the appliance.

Frost protection

Caution

Appliances and accessories that are not completely drained can be destroyed by frost. Completely drain appliance and accessories and protect them against frost.

To avoid damage:

- Completely drain all water from the appliance: Switch the appliance on with detached high pressure hose and detached water supply (max. 1 minute) and wait, until no more water exits at the high pressure connection. Turn off the appliance.
- Store the appliance and the entire accessories in a frost free room.

Maintenance and care

⚠ Danger

Risk of electric shock. Turn off the appliance and remove the mains plug prior to performing any care and maintenance work.

Care

Prior to longer periods of storage, e.g. in the winter:

- Remove filter from suction hose for detergent and clean under running water.
- Pull out the sieve in the water connection using flat-nose pliers and clean under running water.

Maintenance

The appliance is maintenance free.

Troubleshooting

You can rectify minor faults yourself with the help of the following overview. If in doubt, please consult the authorized customer service.

⚠ Danger

Risk of electric shock. Turn off the appliance and remove the mains plug prior to performing any care and maintenance work. Repair work and work on the electrical components may only be performed by an authorised customer service.

Appliance is not running

- Pull on the lever of the trigger gun; the device will switch on.
- Check whether the voltage indicated on the type plate corresponds to the voltage of the mains supply.
- Check the mains connection cable for damages.

Pressure does not build up in the appliance

- Check setting at the spray lance.
- Check water supply for adequate delivery rate.
- Pull out the sieve in the water connection using flat-nose pliers and clean under running water.
- Remove air from appliance before operation.

Switch on the appliance without connection the HP hose (max. 2 minutes) and run it until the water discharging from the HP outlet is free of bubbles. Switch off appliance and reconnect HP hose.

Strong pressure fluctuations

- Clean high-pressure nozzle: Remove dirt and debris from the nozzle bore, using a needle and rinse through with water from the front.
- Check water flow quantity.

Appliance is leaking

- Slight leakage from the appliance pump is normal. If the leakage increases contact the authorized customer service.

No detergent infeed

- Use spray lance with pressure regulation (Vario Power). Turn the spray lance to "Mix" position.
- Clean the detergent suction hose filter.
- Check the detergent suction hose for kinks.

Accessories and Spare Parts

Special accessories

Special accessories expand the possibilities of using your appliance. Please contact your KÄRCHER dealer for further information.

Spare parts

Use only original KÄRCHER spare parts. You will find a list of spare parts at the end of these operating instructions.

Warranty

The warranty terms published by the relevant sales company are applicable in each country. We will repair potential failures of your appliance within the warranty period free of charge, provided that such failure is caused by faulty material or defects in manufacturing. In the event of a warranty claim please contact your dealer or the nearest authorized Customer Service centre. Please submit the proof of purchase. Addresses can be found under:
www.kaercher.com/dealerearch

Technical specifications

Electrical connection

Voltage	110-120 V 1~60 Hz
---------	----------------------

Connected load	1,4 kW
----------------	--------

Protection class	IP X5
------------------	-------

Protective class	II □
------------------	------

Mains fuse (slow-blow)	10 A
------------------------	------

Water connection

Feed pressure	0,2-1,2 MPa
---------------	-------------

Max. feed temperature	40 °C
-----------------------	-------

Min. feed volume	8 l/min
------------------	---------

Performance data

Working pressure	8 MPa
------------------	-------

Max. permissible pressure	11 MPa
---------------------------	--------

Water flow rate	5,2 l/min
-----------------	-----------

Detergent flow rate	0,3 l/min
---------------------	-----------

Recoil force of trigger gun	10 N
-----------------------------	------

Dimensions and weights

Length	280 mm
--------	--------

Width	242 mm
-------	--------

Height	783 mm
--------	--------

Weight	5,2 kg
--------	--------

Subject to technical changes.

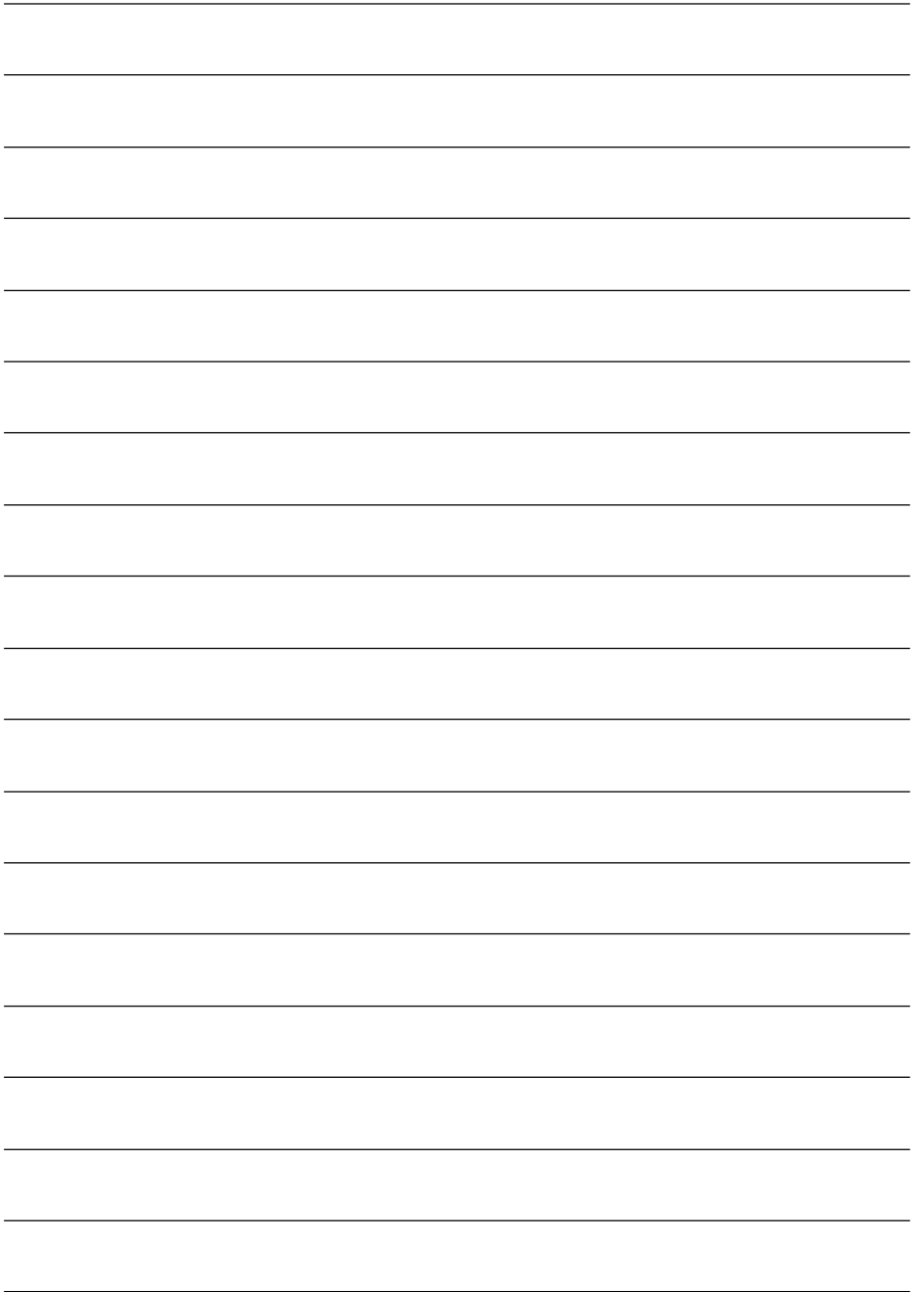

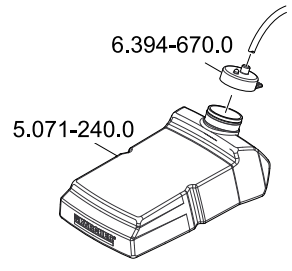
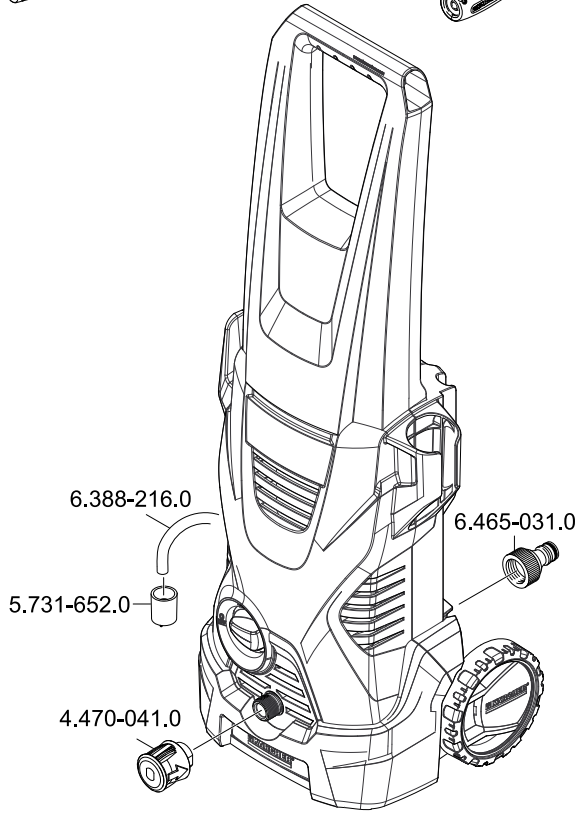
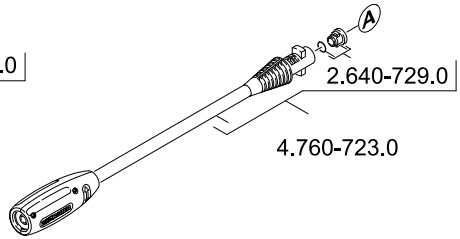
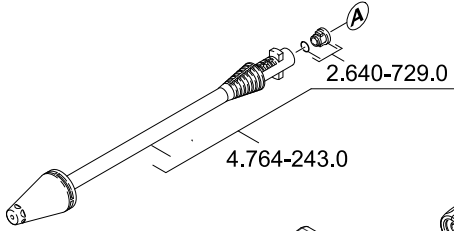
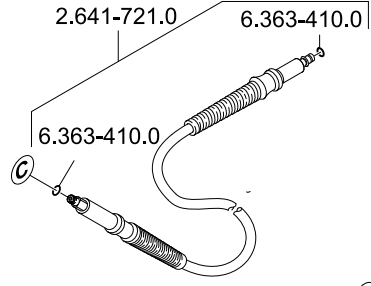
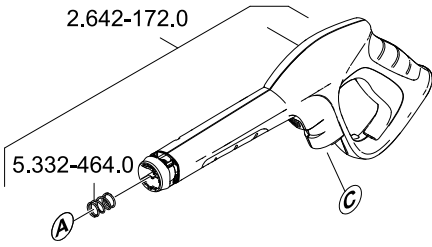



<http://www.kaercher.com/dealersearch>

